



Automotive Lamp Catalogue

Catalogue Lampes Auto
Lichtprogramm Fahrzeuglampen
Catalogo Lampade Automotive
Catálogo Lámparas de Automoción

Imagination at work



 **GE Home & Business Solutions** provides a broad range of products and services throughout the world, including appliances, lighting and electrical distribution solutions. Providing solutions for commercial, industrial and residential use in more than 100 countries, GE Home & Business Solutions uses innovative technologies and "Ecoimagination", a GE initiative to aggressively bring to market new technologies that help customers and consumers meet pressing environmental challenges. GE Lighting – a division of GE Home & Business Solutions – is one of the largest suppliers of light sources in the world. We provide state-of-the-art technology and are able to offer a full range of incandescent lamps, Fluorescent lighting products, Halogen, HID, Compact fluorescent and Automotive lamps. GE has played a leading role in Automotive Lighting for many years. Nowadays we are able to offer a full range of vehicle lamps operating on either 12V or 24V systems. The automotive product range produced in Europe – which is included in this catalogue – is sold all over the world, both for original equipment use and for use in the aftermarket. Upon request a separate catalogue is available on the GE Lighting North American Automotive range.

 **GE Home & Business Solutions** bietet Ihnen eine weltweit breite Palette von Produkten und Dienstleistungen für Haushaltsgeräte, Beleuchtung und elektrische Verteilungssysteme an. GE Home & Business Solutions bietet Lösungen für Gewerbe, Industrie und private Haushalte in mehr als 100 Ländern. GE Home & Business Solutions bietet innovative Technologie und "Ecoimagination", eine Initiative von GE, um mit neuen Technologien die Herausforderungen für eine saubere Umwelt zu meistern. GE Lighting – ein Teil von GE Home & Business Solutions – ist einer der größten Hersteller von Lichtquellen mit modernster Technologie und bietet das gesamte Spektrum an Glüh-, Halogen-, Leuchtstoff-, Kompaktleuchtstoff- und Gasentladungslampen einschließlich Automobilbeleuchtung. GE hatte von Anfang an eine führende Rolle in der Automobilbeleuchtung und bietet heute ein breites Spektrum im 12V und 24V Segment, sowohl für die Erstausrüstung als auch für den Aftermarket. Die Produktpalette für Automobilbeleuchtung in diesem Katalog wird überwiegend in Europa hergestellt. Auf Anfrage senden wir gerne einen Katalog von GE Lighting Nord Amerika für die Automobilbeleuchtung.

 **GE Home & Business Solutions** fornisce una vasta gamma di prodotti e servizi in tutto il mondo, compresi gli elettrodomestici, e soluzioni per l'illuminazione e la distribuzione dell'energia elettrica. Fornisce soluzioni per l'uso in attività commerciali, industriali e residenziali, in più di 100 paesi; GE Home & Business Solutions utilizza tecnologie innovative ed "Ecoimagination", una aggressiva iniziativa di GE per portare sul mercato nuove tecnologie che aiutino i clienti ed i consumatori a soddisfare le nuove sfide a tutela dell'ambiente. GE Lighting – una divisione di GE Home & Business Solutions – è uno dei maggiori fornitori di sorgenti luminose nel mondo, grazie ad una elevata tecnologia, offre una gamma completa di lampade ad incandescenza, lampade fluorescenti, Alogene, HID, fluorescenti compatte e lampade Auto. GE che da sempre svolge un ruolo importante nel mercato "lighting automotive", oggi offre una gamma completa di lampade per auto in 12V e 24V. La gamma di prodotti, fabbricati in Europa, inclusa nel presente catalogo – è venduta in tutto il mondo, sia per il mercato del primo equipaggiamento (OEM) che per il mercato del ricambio. Su richiesta, è disponibile anche un catalogo di lampade auto GE per il mercato nord-americano.

 **GE Home & Business Solutions** fournit une gamme très large de produits et de services dans le monde, comme des appareils électroménagers, des produits et des solutions pour l'éclairage et la distribution de courant électrique. Ces produits et solutions sont vendus dans plus de 100 pays pour les marchés du secteur secondaire et tertiaire, ainsi que pour celui de la consommation en utilisant des process innovants. "Ecoimagination" est une initiative de GE pour apporter des nouvelles technologies sur le marché d'une façon dynamique pour aider ses clients et les consommateurs à gagner face aux défis environnementaux. GE Lighting – une des divisions de GE Home & Business Solutions – est un des plus importants fabricants de sources d'éclairage dans le monde fournissant des produits les plus modernes dans une gamme très large des lampes à incandescence, les tubes fluo, des lampes halogène et fluo-compactes, les lampes à décharge et les lampes auto. GE a joué un rôle important dans le domaine de l'éclairage automobile dès le début et offre une gamme très large en 12V et 24V. Ces sont les lampes destinées à l'Europe qui sont présentées dans ce catalogue mais vous pouvez avoir – sur demande – un catalogue spécial pour les lampes du marché nord-américain. Les lampes figurant dans ces catalogues sont vendues mondialement aussi bien pour la première monte que pour le marché de la rechange.

 **GE Home & Business Solutions** ofrece una amplia gama de productos y servicios en todo el mundo, incluyendo electrodomésticos, iluminación y distribución de soluciones para electricidad. A la vez también proporciona soluciones para empresas comerciales, industriales así como de hogar en más de 100 países. GE Home & Business Solutions utiliza tecnologías innovadoras, y entre ellas está "Ecoimagination", una iniciativa de GE que pretende introducir en el mercado nuevas tecnologías que puedan ayudar a los clientes y consumidores a realizar cambios importantes y de mejora en el medio ambiente. GE Lighting – una de las divisiones de GE Home & Business Solutions – es uno de los más importantes proveedores de fuentes de luz en el mundo con la tecnología más avanzada, ofreciendo una gama completa de lámparas incandescentes, así como productos de iluminación fluorescente, halógenas, HID, fluorescencia compacta y lámparas de automoción. GE ha desempeñado desde su inicio un papel de liderazgo en la iluminación del automóvil. Actualmente estamos ofreciendo una gama completa de lámparas para automoción en 12V y 24V. La gama de productos para automoción que fabricamos – y que se incluye en el presente catálogo – se vende en todo el mundo tanto para uso en equipo original (primer equipo OEM) así como para el mercado del recambio (AM). También disponemos de un catálogo, que bajo solicitud, podrá comprobar nuestra gama de disponibilidad en lámparas de automoción GE Lighting para el mercado de Norte América.



Certification

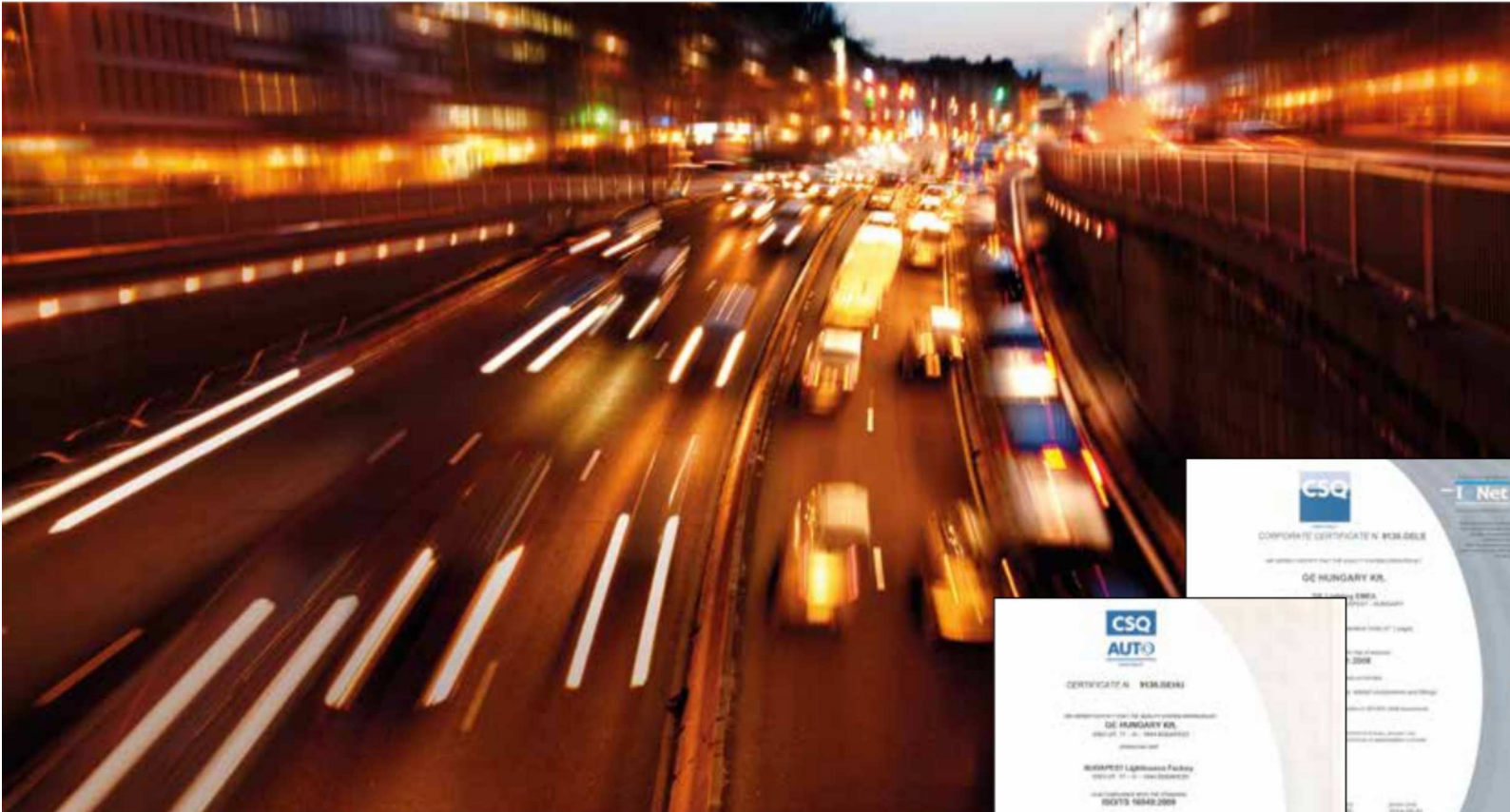

 The company is on the Approval list of many of the worlds car manufacturers, where quality and performance are key measurements. The reliability and quality of automotive lamps is ensured by:

- Computer-managed and controlled design process
- Fully automated production lines
- High level of quality assurance system
- Continued investment programs
- A commitment to continuous improvement

 Nos lampes figurent dans les références en homologation de beaucoup de constructeurs dans le monde qui est une reconnaissance de leur qualité et de leur performance. La fiabilité et la qualité sont assurées

- par un procédé de fabrication assisté et contrôlé par ordinateur
- par des lignes de fabrication automatiques
- et par un système de qualité de haut niveau

 Unser Unternehmen befindet sich auf den meisten Freigabelisten der weltweiten Automobilindustrie, dort wird der Schwerpunkt auf Qualität und Leistungsfähigkeit gesetzt.

- Die verlässliche Qualität der Automobillampen wird erreicht durch
- computergestützte 100% Qualitätskontrolle
 - vollautomatische Produktionsverfahren
 - hochentwickelte Qualitätssicherungssysteme

 Nuestra compañía está Homologada en la mayoría de fabricantes de automóviles en el ámbito mundial, lo que significa que las medidas de calidad son claves. La fiabilidad en la calidad de nuestras lámparas de automoción está garantizada por:

- Control total del diseño de proceso por ordenador.
- Líneas de producción totalmente automáticas.
- Los más estrictos controles de calidad.

 L'azienda ed i suoi prodotti sono omologati dai principali costruttori di automobili di tutto il mondo per i quali la qualità e le prestazioni sono parametri fondamentali. L'affidabilità e qualità delle nostre lampade auto sono garantite da:

- Controllo gestione computerizzata totale del processo di sviluppo del prodotto
- linee di produzione completamente automatizzate
- elevato livello di sistema di garanzia della qualità.



ISO 9001, ISO TS 16949 and ISO 14001 quality system certification



ECE compliance, homologation



Global OEM customer base



EoLV, ROHS compliance



Use of UV cut glass, safe for use in plastic headlights

Contents

Introduction, Certification, Contents, Automotive Lamps Introduction - Einführung - Introducción - Introduzione	2-7
"XENSATION™" - D1S, D1R, D2S, D2R, D3S, D3R, D4S, D4R headlight lamps 12V Lampes principales D1S, D1R, D2S, D2R, D3S, D3R, D4S, D4R - 12V SAE-Hauptscheinwerferlampen D1S, D1R, D2S, D2R, D3S, D3R, D4S, D4R - 12V Lámparas de faro D1S, D1R, D2S, D2R, D3S, D3R, D4S, D4R - 12V Lampade per proiettori, D1S, D1R, D2S, D2R, D3S, D3R, D4S, D4R "XENSATION™"	8-9
12V halogen headlight lamps - "PREMIUM" 12V Lampes principales halogene - Halogen Scheinwerferlampen - Lámparas de faro halógenas - Lampade per proiettori alogene "PREMIUM"	10-11
MEGALIGHT ULTRA +120	12-13
MEGALIGHT ULTRA +90	14-15
MEGALIGHT PLUS	16-17
SPORTLIGHT - incl. miniature lamps	18-19
SPORTLIGHT ULTRA	20-21
EXTRA LIFE - incl. miniature lamps	22-23
RALLY - OFF ROAD	24
Adjustable LED Daytime Running Lamp	25
MOTORCYCLE	26
12V Headlight lamps - R2, H4 - upper and lower beam, H1, H2, H3, H7, H8, H9, H10, H11, HB3, HB4 - single filament lamps 12V Lampes principales H4, R2, Lampes monofilament H1, H2, H3, H7, H8, H9, H10, H11, HB3, HB4 - 12V Zweifaden-Hauptscheinwerferlampen H4, R2, Einfadenlampen H1, H2, H3, H7, H8, H9, H10, H11, HB3, HB4 - 12V Lámparas de faro H4, R2 de doble filamento, Lámparas de un filamento H1, H2, H3, H7, H8, H9, H10, H11, HB3, HB4 - 12V Lampade per proiettori H4, R2, Lampade ad un filamento H1, H2, H3, H7, H8, H9, H10, H11, HB3, HB4	27
Miniature lamps - "PREMIUM" Lampes miniatures - Miniaturlampen - Lámparas miniatura - lampade miniature "PREMIUM"	28-29
12V Tail, stop and direction lamps 12V Feu rouge/Stop/Clignotant - 12V Blink-, Brems- und Schlußlichtlampen - 12V Lámparas traseras, freno e intermitente 12V Lampade per fanali posteriori, luci di arresto e direzione	30
12V Interior lamps, miniature halogen lamps 12V Lampes éclairage intérieur, lampes miniatures halogene - 12V Lampen für Innenbeleuchtung, miniatur-halogenlampen - 12V Lámparas de interior, lámparas halógenas miniatura - 12V Lampade per illuminazione interna, lampade miniature alogene	31
12V Tail, direction, parking and indicator lamps 12V Feu rouge/clignotant/Feu de position/Répetiteur latéral - 12V Blink-, Brems- und Schlußlichtlampen - 12V Lámparas traseras, marcha atrás e indicadoras - 12V Lampade per fanali posteriori, luci di arresto e direzione	32
12V Wedge base lamps with and without plastic cap 12V Lampes "wedge base" avec ou sans culot plastique - 12V Glassockellampen mit und ohne Steckfassung - 12V Lámparas con casquillo de vidrio y lámparas con base de plástico - 12V Lampade con attacco vetro e/o in plastica	33
"Heavy Star" - Heavy Duty Long Life - 24V Truck lamps with longer life and increased robustness Les lampes 24V pour les poids lourds avec une durée de vie allongée et une résistance accrue - Lampade per Camion : 24V, durata di vita e robustezza superiori alle lampade standard - Lámparas de camión de 24V, con una duración de vida más larga y una mayor solidez - 24V Lampen für LKW und Busse mit längerer Lebensdauer und höherer Robustheit	34-35
24V Headlight lamps - upper and lower beam 24V Lampes principales - 24V Hauptscheinwerferlampen - 24V Lámparas de faro - 24V Lampade per proiettori - abbagliante ed anabbagliante	36
24V Tail, direction, parking and indicator lamps 24V Feu rouge/clignotant/Feu de position/Répetiteur latéral - 24V Blink-, Brems- und Schlußlichtlampen - 24V Lámparas traseras, marcha atrás e indicadoras - 24V Lampade per fanali posteriori, luci di arresto e direzione	37-38
24V Interior lamps 24V Lampes éclairage intérieur - 24V Lampen für Innenbeleuchtung - 24V Lámparas de interior - 24V Lampade per illuminazione interna	39
24V Tail, stop and direction lamps 24V Feu rouge/Stop/Clignotant - 24V Blink-, Brems- und Schlußlichtlampen - 24V Lámparas traseras, freno e intermitente - 24V Lampade per fanali posteriori, luci di arresto e direzione	39
Lamp kits	40
Displays	41
Packaging, blisters Emballage - Verpackungen - Embalaje - Imballo	42-44
Symbols, marking	45
Lamp bases Culot - Sockelübersicht - Casquillos de lámparas - Attacchi lampade	46

Legend

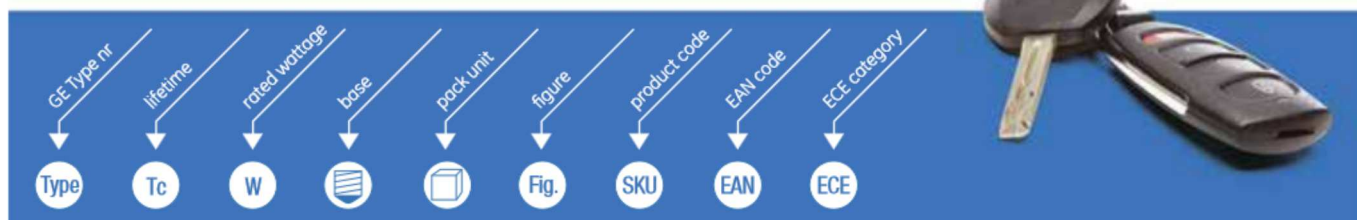

12V Automotive Lamps

front light

D1S 53620	D1R 53740	D2S 53500	D2R 53510	D3S 53660	D3R 53730	D4S 53670	D4R 53680	H1 50310/1U	H3 50340U	H4 50440U	H7 58520U	H9 53100HU	H11 53110HU	HB3 53060U	HB4 53070U
--------------	--------------	--------------	--------------	--------------	--------------	--------------	--------------	----------------	--------------	--------------	--------------	---------------	----------------	---------------	---------------

side turn signals

W5W 501	WY5W 501NA	T4W 2662
------------	---------------	-------------

parking light

T4W 2662	W5W 501	W5W NB 501 NB	H6W 52830U
-------------	------------	---------------------	---------------

fog light

H1 50310/1U	H3 50340U	H7 58520U	H8 53090HU	H10 53080U	H11 53110HU
----------------	--------------	--------------	---------------	---------------	----------------

side signals, warning lights

P21W 1057	PY21W 1056	W21W 7440	WY21W 7440NA
--------------	---------------	--------------	-----------------

dashboard and interior light

W5W 501	W3W 504	1.2W 5301	T4W 2662	C5W 7546	fest 10W 7576	H6W 52830U
------------	------------	--------------	-------------	-------------	---------------------	---------------

parking lights

R5W 2619	R10W 2641	P21/5W 1077	P21/4W 1122	W21/5W 7443
-------------	--------------	----------------	----------------	----------------

stop light (CHMSL)

W5W 501	W16W 921
------------	-------------

license plate

R5W 2619	C5W 7546	W5W 501	T4W 2662
-------------	-------------	------------	-------------

side signals, warning lights

P21W 1057	PY21W 1056	W21W 7440	WY21W 7440NA
--------------	---------------	--------------	-----------------

trunk light

R5W 2619	C5W 7546	fest 10W 7576
-------------	-------------	------------------

stop lights

P21W 1057	P21/5W 1077	P21/4W 1122	W21/5W 7443	W21W 7440
--------------	----------------	----------------	----------------	--------------

fog lights

P21W 1057	W21W 7440
--------------	--------------

reverse light

P21W 1057	W16W 921	W21W 7440
--------------	-------------	--------------

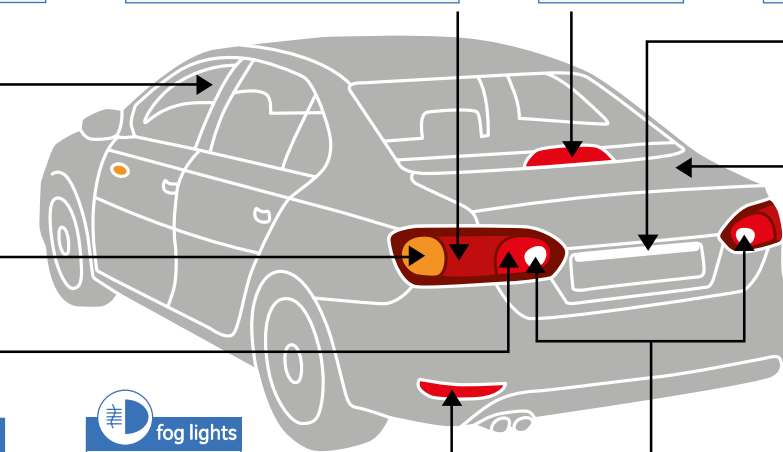
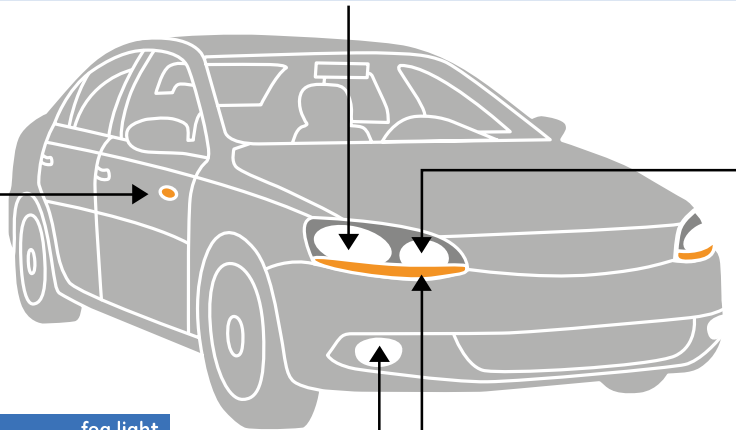

24V Commercial Vehicles

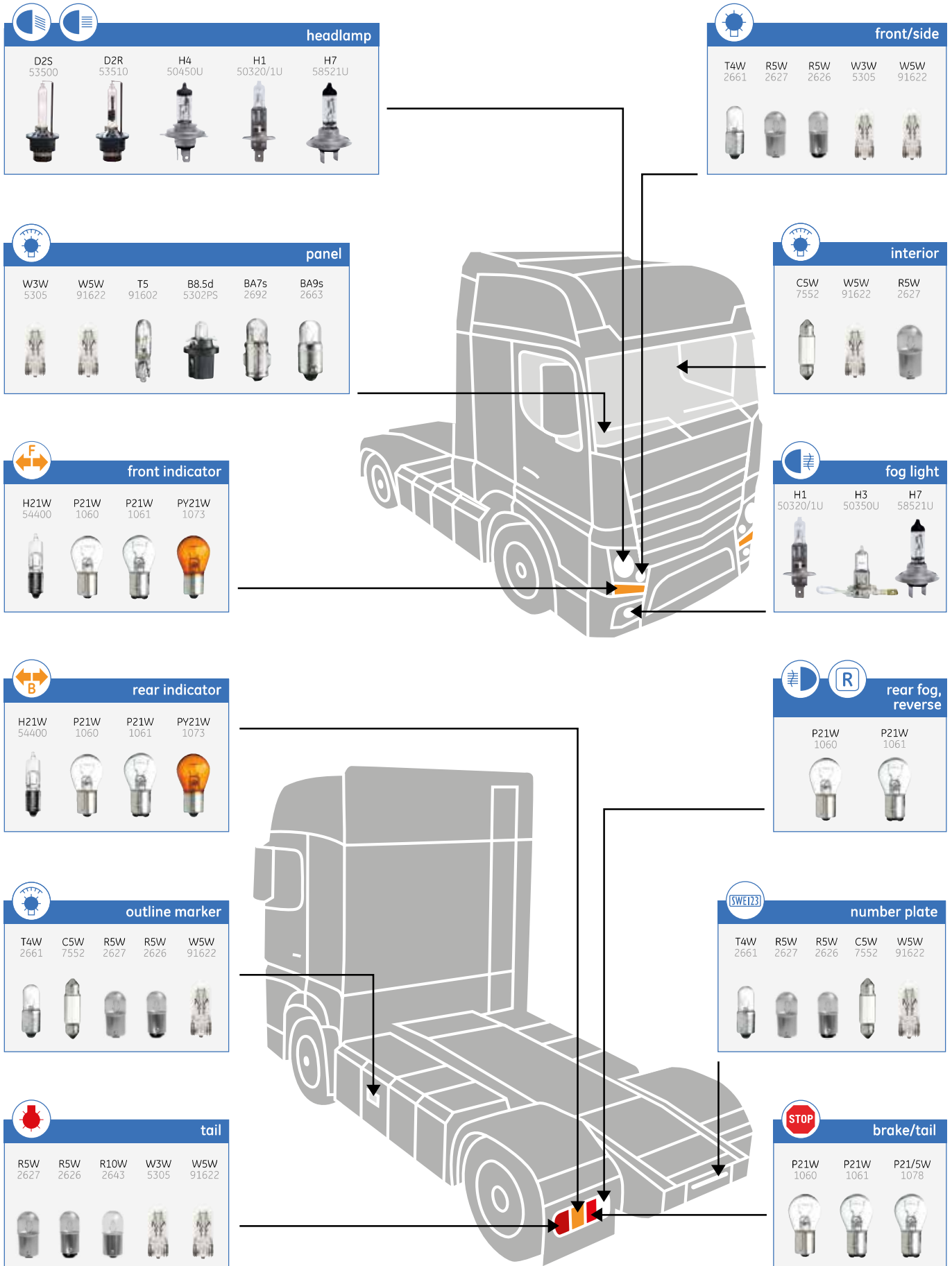

Motorcycles

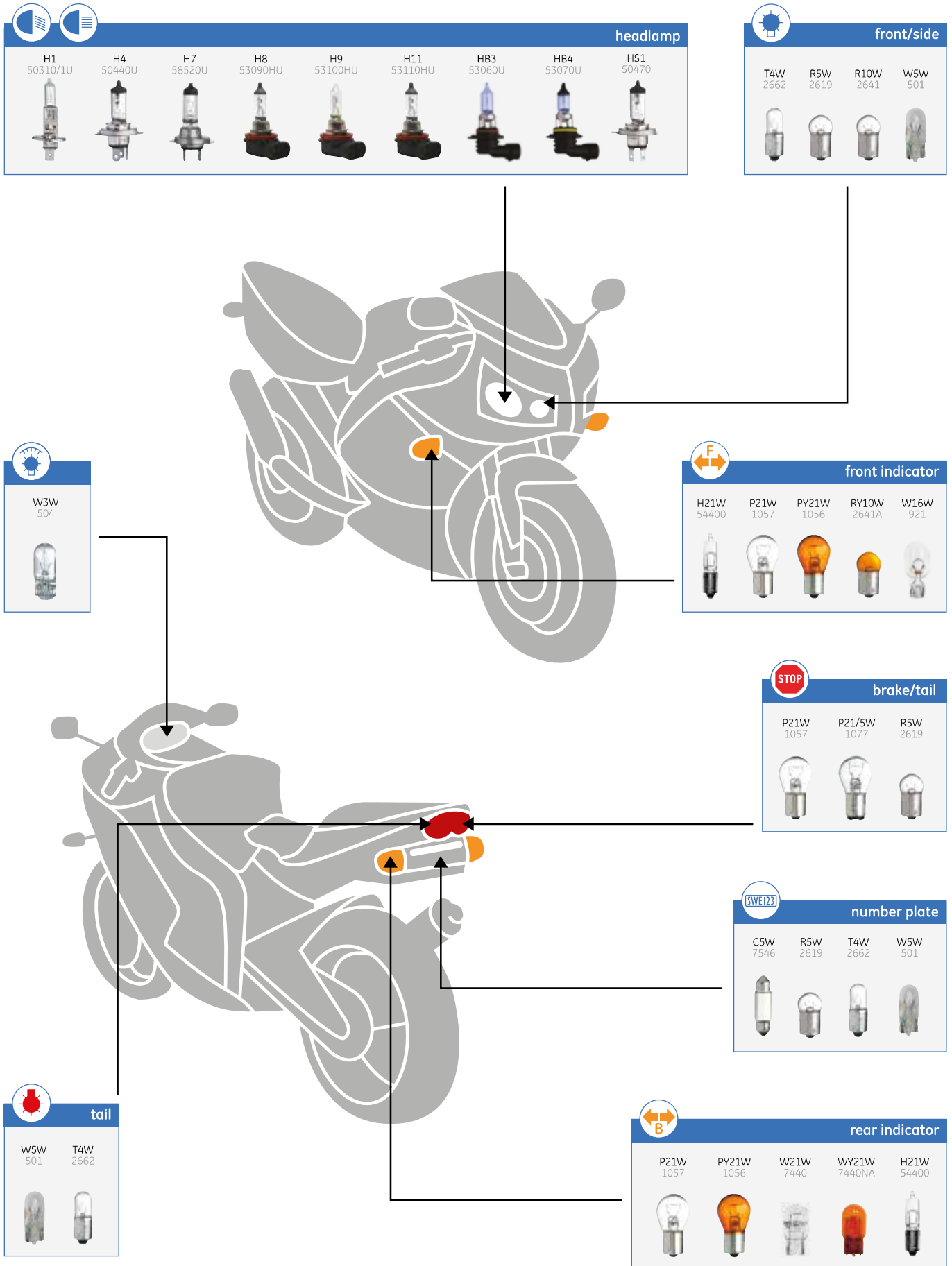

Xenon High Intensity Discharge lamps



- Thanks to our latest lighting technology, GE Xensation lamps provide a major leap in road safety over conventional halogen lamps due to enormous increase in the illuminated field of vision.
- Better visibility and illumination- the light emitted provides the driver with many benefits. It assists the human eye and allows better visibility and improved hazard awareness, allowing the driver to navigate poor driving conditions with increased confidence and with less fatigue.
- Lower power consumption – 35W only instead of 55W (ordinary halogen lamp power consumption).
- Better durability – excellent vibration and shock resistance giving significantly greater reliability.
- Optically advantageous whiter light compared to halogen lamps designed to give a colour that is closer to natural daylight.

Type	Color temperature (Kelvin)
Xensation Standard D1, D2, D3, D4	4200
White Xensation D1, D2	4800*

* Colour temperature exceeds 5500K in majority of life time.

GE 4800K* D1 & D2 lamps White Xensation

4800 kelvin



4200 kelvin



Light up the road with style and brilliant white light

Up to 20% more light on the road - maximum illuminance

- Produces a crisp, bright light that is closer to daylight.
- Better visibility in extreme weather conditions, higher visibility in peripheral areas.
- Less fatigue effect during night driving.

D1S, D1R, D2S, D2R, D3S, D3R, D4S, D4R

--	--	--	--	--	--	--	--

Xenon-HID – Headlight lamps

Headlight lamps – upper and lower beam
 Lampes principales
 Hauptscheinwerferlampen
 Lámparas de faro – doble filamento
 Lampade per proiettori – abbagliante ed anabbagliante

53620	D1S	35	PK32D-2	1/4/12	1	78129	0043168781299
53740	D1R	35	P32D-3	1/4/12	2	93011095	0064894504440
53500	D2S	35	P32D-2	1/8/32	3	93036	0043168930369
53500	D2S	35	P32D-2	1/3/12	3	20077	0043168930369
53510	D2R	35	P32D-3	1/8/32	4	93218	0043168932189
53510	D2R	35	P32D-3	1/3/12	4	20079	0043168932189
53660	D3S	35	PK32D-5	1/4/12	1	14178	0043168141789
53730	D3R	35	PK32D-6	1/4/12	2	93011085	0064894504457
53670	D4S	35	P32D-5	1/3/12	3	14185	0043168141857
53680	D4R	35	P32D-6	1/3/12	4	14186	0043168141864
NEW 53750 - 4800K*	D1S	35	PK32d-2	1/4/12	5	93021374	64894530760
NEW 53760 - 4800K*	D2S	35	P32d-2	1/3/12	6	93019380	64894530333
NEW 53770 - 4800K*	D2R	35	P32d-3	1/3/12	7	93019901	64894530357

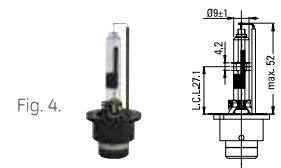
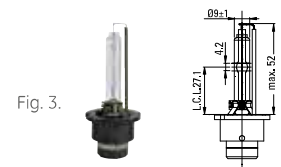
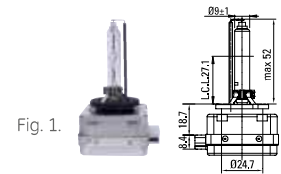

* Colour temperature exceeds 5500K in majority of life time.



Halogen headlight lamps

lighting your way ...

As well as the basic range, GE automotive also offers the premium range, based on special lamp designs. The premium range includes: Megalight Ultra +120, Megalight Ultra +90, Megalight Plus, Sportlight, Extra Life, Heavy Star, Rally. The premium lamps have additional benefits in terms of life, colour, vibration resistance or wattage.

The premium lamps are also E1 marked, making their use on the EU roads possible, with the exception of Rally lamps that were designed for off-road usage.

Extra life lamps have enhanced life, Megalight Plus and Ultra lamps possess increased luminance, Sportlight halogen lamps give intense blue-white light.

Colour temperature-luminance-life comparisons for the premium range

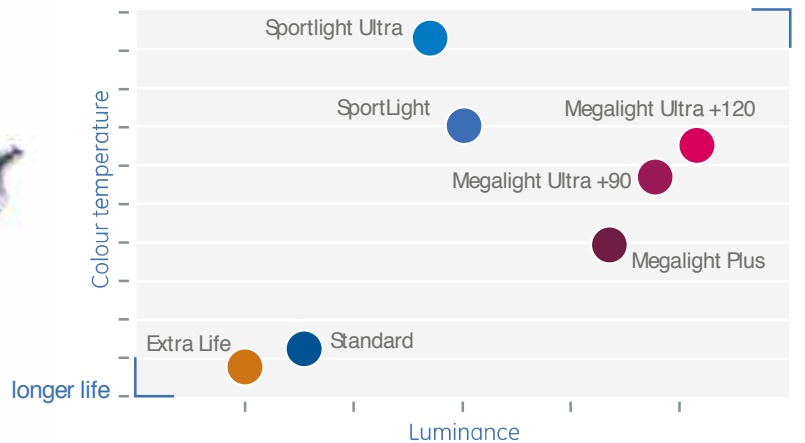

UPGRADE your car with GE premium lamps

Megalight Ultra +120
up to **120%** more light

Megalight Ultra +90
up to **90%** more light

Megalight Plus
50-60% more light

Sport Light
when you really want to **see and be seen**



Sportlight Ultra
Intense white light comparable with xenon – 4200 Kelvin

Extra Life
better economy for daytime lighting

Heavy Star - 24
Longer life, increased robustness

Rally
for **off-road** use only

“Reliable” range
quality- performance fully replacable with OEM lamps

			
Megalight Ultra +120	●		●
Megalight Ultra +90	●		●
Megalight Plus	●		●
Sport Light	●		●
Sportlight Ultra	●		●
Extra Life	●	●	●
Heavy Star - 24	●	●	●
Rally	●	●	●
“Reliable” range	●	●	●

Operational voltage is a critical parameter influencing the life time of the automotive lamps. The life of the lamp is sensitive to the operation voltage of the car, 1% of change of the voltage results in 12-15% change of life with opposite sign.

More light

better visibility

proved driving performance

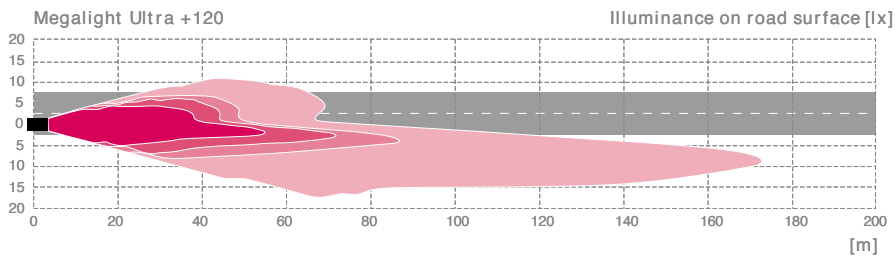
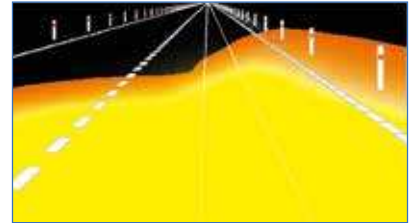
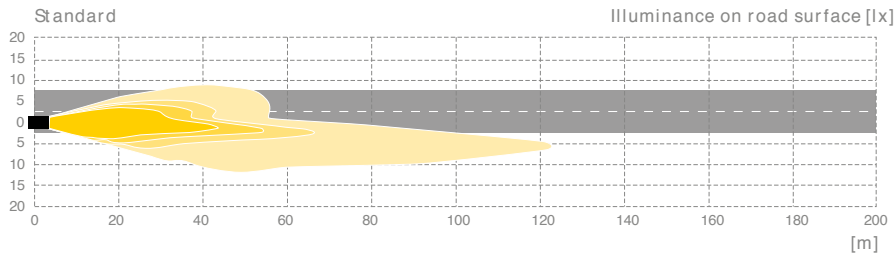

9 10 11

●				●	●	●
●				●	●	●
●						
●					●	●
●						
●						
●	●	●	●	●	●	●



The special quartz glass used for GE automotive lamps cuts the UV component of light, it means that GE automotive lamps can safely be used in plastic reflectors without the risk of discoloration.

Megalight Ultra +120



Up to 120% more light on the road

New level of performance - optimized design with 100% xenon gas fill.

- Most intense and powerful lamp in terms of luminance, for safer driving
- Improved headlamp illumination level helps in reduction of accidents at night time/in poor visibility conditions

Bis zu 120% mehr Licht auf der Straße

Neues Leistungsniveau - Prozessoptimiertes Design mit 100 %-iger Xenongasfüllung.

- Intensivste und Leistungsstärkste Lampe in Bezug auf Helligkeit, sorgt für sicheres Fahren
- Erhöht die Lichtintensität des Scheinwerfers und verringert somit die Unfallgefahr bei Dunkelheit
- Verbesserte Lichtintensität hilft bei der Verringerung von Unfällen in der Nacht und bei schlechten Sichtverhältnissen

Fino al 120% luce in piu' sulla strada

Nuovo livello di performance - disegno ottimizzato con il 100% di gas Xenon.

- La lampada fornisce una luce piu' potente ed intensa, per una guida piu' sicura
- Un miglior livello di illuminazione proiettata sulla strada contribuisce a ridurre potenziali incidenti in caso di ridotta visibilità.

Jusqu'à 120% plus de lumière sur la route

Niveau de performance supérieure - conception optimisée, remplie 100% de gaz xénon.

- Lampe la plus intense en terme de luminosité pour la sécurité de votre conduite
- Le niveau d'illumination accrue des projecteurs aide à diminuer les accidents pendant la nuit et lorsque la visibilité est mauvaise.

Hasta un 120% más de luz en carretera

Un nivel más elevado de rendimiento - diseño mejorado con un 100% de gas xenon.

- Con más fuerza e intensidad, en términos de luminosidad, para obtener una conducción más segura
- La mejora del nivel de iluminación en las lámparas principales ayuda en la reducción de accidentes nocturnos o en condiciones de mala visibilidad

Megalight Ultra +90



Up to 90% more light on the road

High performance lamps for visibility, convenience and style

- Improved driving performance at night
- Greater illumination combined with whiter light add safety to your driving.



Usur à 90% plus de

lumière sur la route

Lampes à haute performance pour le confort visuel et style

- Meilleure performance de conduite dans la nuit
- Luminosité accrue combiné avec lumière plus blanche augmente la sécurité de votre conduite.



Is up to 90% mehr Licht auf der Straße

Verbessern Sie Ihr Fahrverhalten durch stressfreies Sehen, dank des helleren Lichtes

- Verbesserte Sicht bei Nacht.
- Hellere Beleuchtung kombiniert mit blau-weißem Licht bedeutet zusätzliche Sicherheit für Ihre Fahrt.



Hasta un 90% más de

luz en carretera

Alto rendimiento. Lámparas que aúnan visibilidad, comodidad y estilo

- Para una mejor conducción nocturna.
- Una mayor iluminación combinada con una luz blanca más intensa. Añade seguridad a la conducción.



Fino al 90% di luce in più sulla strada

lampade ad alta prestazione in termini di visibilità, convenienza e stile

- Migliori prestazioni di guida durante la notte.
- Una migliore illuminazione combinata con una luce più „bianca“ aumenta la tua sicurezza.



--	--	--	--	--	--	--	--	--

Megalight Ultra +90 - Halogen headlight lamps

Headlight lamps - upper and lower beam
 Lampes principales
 Hauptscheinwerferlampen
 Lámparas de faro
 Lampade per proiettori - abbagliante ed anabbagliante

50440SXU	350	H4	60/55	P43t	2/18/72 display	1	93013070	0043168735001
					2/20 blister	1	74153	0043168741538
58520SXU	350	H7	55	PX26d	2/18/72 display	2	93013272	0043168969239
					2/20 blister	2	74154	0043168741545
50310XU	350	H1	55	P14,5s	2/18/72 display	3	93013273	0043168969468
					2/20 blister	3	96948	0043168969482
53060XU	200	HB3	60	P20d	2/12/48 display	4	79295	0043168792950
53070SXU	350	HB4	51	P22d	2/12/48 display	5	79296	0043168792967
53110SXU	350	H11	55	PGJ19-2	2/12/48 display	6	79297	0043168792974

* Tc (hour) is the time up to which 63,2 % of tested lamps have ended their lives. Measured according to GE life test specification. The life of the lamp is sensitive to the operation voltage of the car, 1% of change of the voltage results in 12-15% change of life with opposite sign.

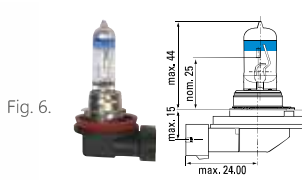
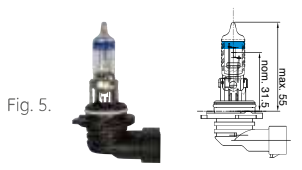
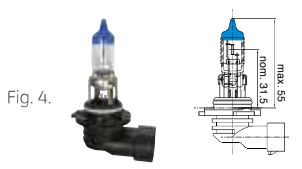
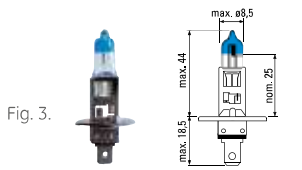
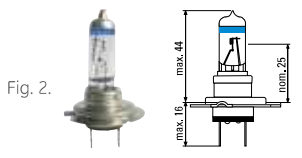
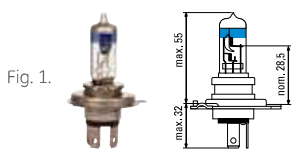

Always change the headlamps by pair.

Megalight Plus 50, 60



 **Up to 60% more light on the road**

- Special high luminance lamp design
- Longer beam
- Brighter illumination

 **60% mehr Licht auf der Straße**

- Spezielles Design für größtmögliche Beleuchtungsstärke
- Größere Leuchtweite
- Hellere Beleuchtung

 **Ino al 60% luce in più sulla strada**

- Speciale design della lampada ad alta luminosità
- Fascio più lungo
- Luminosità più brillante

 **Jusqu'à 60% plus de lumière sur la route**

- Une conception pour une luminance plus élevée
- Un faisceau plus long
- Une illumination plus brillante

 **Hasta un 60% más de luz en carretera**

- Diseño especial de la lámpara de alta luminosidad
- Haz luminoso de mayor alcance
- Iluminación más intensa

--	--	--	--	--	--	--	--	--

Megalight Plus 50, 60 - Halogen headlight lamps

Headlight lamps – upper and lower beam
 Lampes principales
 Hauptscheinwerferlampen
 Lâmparas de faro
 Lampade per proiettori – abbagliante ed anabbagliante

50440MPU	300	H4	60/55	P43t	2/18/72 display	1	93012268	0043168916189
					1/12/48 display	1	12791	0043168127912
					2/20 blister	1	93361	0043168933612
58520MPU	500	H7	55	PX26d	2/18/72 display	2	93012270	0043168937689
					1/20/80 display	2	12904	0043168129046
					2/20 blister	2	19759	0043168197595
50310MPU	600	H1	55	P14,5s	2/18/72 display	3	93012269	0043168936255
					1/20/80 display	3	12896	0043168128964
					2/20 blister	3	19758	0043168197588

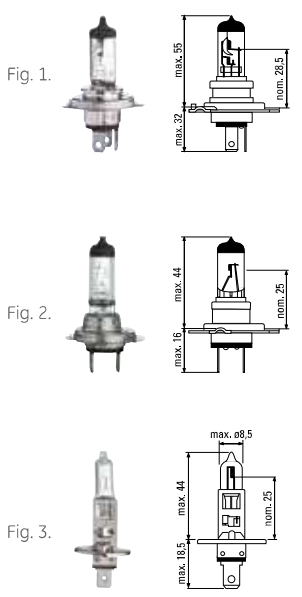

* **Tc (hour)** is the time up to which 63,2 % of tested lamps have ended their lives. Measured according to GE life test specification. The life of the lamp is sensitive to the operation voltage of the car, 1% of change of the voltage results in 12-15% change of life with opposite sign.



Sportlight



When you really want to see and be seen

Intense blue-white light up to 50% more light on the road, or faster signal

- Higher visibility in peripheral viewing
- Better visibility in extreme weather conditions
- Faster signal, earlier notice - miniature lamps

Wenn Sie wirklich gut sehen und gesehen werden sollen

Intensives blau-weißes Licht mit Xenon Effekt, welches bis zu 50% mehr Licht auf die Straße bringt

- Bessere Sicht in den Außenrandbereichen um zu sehen und gesehen zu werden
- Bessere Sichtbarkeit bei extremen Wetterbedingungen
- Verbesserte und schnellere Reaktionszeit - Miniaturlampen

Le potete avere e essere visti

Un'intensa luce di colore blu-bianca che garantisce un'illuminazione della strada superiore del 50%

- Visibilità maggiore nella visione periferica "per vedere ed essere visti"
- Migliore visibilità in condizioni atmosferiche difficili
- Segnale più veloce, che permette di essere visti vedere prima - lampade miniature

Lors que vous voulez vraiment voir et être vu

Une lumière intense bleue-blanche et jusqu'à 50% plus de lumière sur la route, ou un signallement et un aperçu plus rapide

- Une visibilité périphérique plus élevée et dans des conditions climatiques extrêmes
- Un signallement et un aperçu plus rapide - lampes miniatures

Para ser visto con claridad

Luz intensa blanca azulada, que ofrece hasta un 50% más de iluminación en carretera

- Mayor visibilidad en el campo de visión periférico
- Mayor visibilidad en condiciones climáticas extremas - lámparas miniatura

Street
Legal

--	--	--	--	--	--	--	--	--

Sportlight - Halogen headlight lamps [Go to more lights on the road](#)

Headlight lamps - upper and lower beam
 Lampes principales
 Hauptscheinwerferlampen
 Lámparas de faro
 Lampade per proiettori - abbagliante ed anabbagliante

50440SPU	480	H4	60/55	P43t	2/18/72 display	1	93013292	0043168792981
					2/20 blister	1	97132	0043168971324
58520SPU	250	H7	55	PX26d	2/18/72 display	2	93013293	0043168792998
					2/20 blister	2	97131	0043168971317
50310NHSU	130	H1	55	P14,5s	2/18/72 display	3	93013294	0043168907613
					2/20 blister	3	73343	0043168733434
53810NHSU	235	HB3	60	P20d	2/12/48 display	4	79304	0043168793049
53820NHSU	760	HB4	51	P22d	2/12/48 display	5	79303	0043168793032

Sportlight - Miniature lamps

Tail, direction, parking and indicator lamps
 Feu rouge/clignotant/Feu de position/Répetiteur latéral
 Blink-, Brems- und Schlußlichtlampen
 Lámparas traseras, marcha atrás e indicadores
 Lampade per fanali posteriori, luci di arresto e direzione

1057NH	320	P21W	21	BA15s	1/10/200	6	45690	0043168456906
					10/200	6	45348	0043168453486
1077NH	160/1600	P21/5W	21/5	BAY15d	1/10/200	7	45687	0043168456876
					10/200	7	45346	0043168453462
2619NH	300	R5W	5	BA15s	1/10/200	8	45685	0043168456852
					10/200	8	45342	0043168453424
2641NH	300	R10W	10	BA15s	1/10/200	8	45684	0043168456845
					10/200	8	45337	0043168453370
501NH	500	W5W	5	W2,1x9,5d	10/200	9	76108	0043168761086

* Tc (hour) is the time up to which 63,2 % of tested lamps have ended their lives. Measured according to GE life test specification. The life of the lamp is sensitive to the operation voltage of the car, 1% of change of the voltage results in 12-15% change of life with opposite sign.

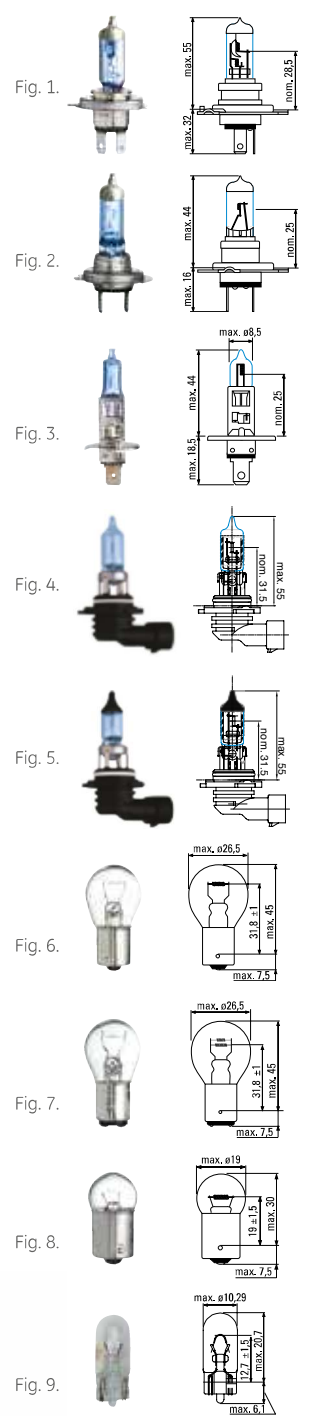

Always change the headlamps by pair.

Sportlight Ultra 4200 Kelvin



Intense white light comparable with Xenon – 4200 Kelvin

- Up to 30% more light on the road
- Higher visibility in peripheral viewing
- Better visibility in extreme weather conditions

Une lumière intense bleu-blanche similaire aux lampes Xenon – 4200 Kelvin

- jusqu'à 30% plus de lumière sur la route
- Une visibilité périphérique plus élevée et dans des conditions climatiques extrêmes

Intensives blau-weißes Licht mit Xenon Effekt – 4200 Kelvin

- Welches bis zu 30% mehr Licht auf die Straße bringt
- Bessere Sicht in den Außenrandbereichen um zu sehen und gesehen zu werden
- Bessere Sichtbarkeit bei extremen Wetterbedingungen

Intensa blanca azulada 4200 Kelvin

- Ofrece hasta un 30% más de iluminación en carretera
- Mayor visibilidad en el campo de visión periférico
- Mayor visibilidad en condiciones climáticas extremas

Un'intensa luce di colore blu-bianca – 4200 Kelvin

Un'intensa luce di colore blu-bianca che garantisce un'illuminazione della strada superiore del 30%

- Garantisce un'illuminazione della strada superiore del 30%
- Maggiore visibilità periferica: "per vedere ed essere visti"
- Migliore visibilità in condizioni atmosferiche avverse

Type	Tc	ECE	W			Fig.	SKU	EAN
------	----	-----	---	--	--	------	-----	-----

Sportlight Ultra - Halogen headlight lamps [Go to more light on the road Xenon look 4200K](#)

Headlight lamps - upper and lower beam
 Lampes principales
 Hauptscheinwerferlampen
 Lámparas de faro
 Lampade per proiettori - abbagliante ed anabbagliante

50440SBU	250	H4	60/55	P43t	2/18/72	1	90901	0043168909013
					2/20 blister	1	93012846	0064894521812
58520SBU	250	H7	55	PX26d	2/18/72	2	90902	0043168909020
					2/20 blister	2	93012861	0064894521904
50310SBU	250	H1	55	P14,5s	2/18/72	3	90900	0043168909006
					2/20 blister	3	93012845	0064894521805

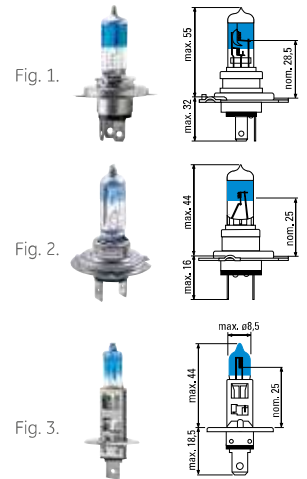

* **Tc (hour)** is the time up to which 63,2 % of tested lamps have ended their lives. Measured according to GE life test specification. The life of the lamp is sensitive to the operation voltage of the car, 1% of change of the voltage results in 12-15% change of life with opposite sign.



Extra Life



Extended Lifetime

Double the life of standard bulbs

- Suitable for Daytime Running Light (DRL) use
- Ensures safe driving during day and night



Durée de vie prolongée

Double la vie des lampes standard

- Convenable pour l'utilisation DRL
- Pour conduire en sécurité - spécialement conçues pour la conduite de jour comme de nuit



Lebensdauer verdoppelt Superlonglife

Lebensdauerverdoppelung gegenüber Standardglühlampen

- Besonders geeignet auch als Tagfahrlichtlampen-Generation (DRL)
- Sorgt für sicheres Fahren bei Tag und bei Nacht



Útil prolongada

Duplica la vida útil de las bombillas estándar

- Adecuada para su uso como luz diurna (DRL)
- Garantiza una conducción segura día y noche



Una durata

Doppia durata rispetto alle tradizionali lampadine

- Ideale come lampadine DRL (Daytime Running Light)
- Garantisce una guida sicura durante il giorno e la notte



--	--	--	--	--	--	--	--	--

Extra Life - Halogen headlight lamps

Headlight lamps – upper and lower beam
 Lampes principales
 Hauptscheinwerferlampen
 Lámparas de faro
 Lampade per proiettori – abbagliante ed anabbagliante

50440LU_DPU	3500	H4	60/55	P43t	2/18/72 display	1	93012336	0043168174626
					2/20 blister	1	19682	0043168196826
					1/10/100	1	95396	0043168953962
58520LU_DPU	1250	H7	55	PX26d	2/18/72 display	2	93012303	0043168174633
					2/20 blister	2	19686	0043168196864
					1/10/100	2	95397	0043168953979
50310LU_DPU	2000	H1	55	P14,5s	2/18/72 display	3	93012337	0043168174657
					1/10/100	3	93011331	0064894508158
					2/20 blister	3	19685	0043168196857
50340LU_DPU	2500	H3	55	PK22s	1/10/100	4	17464	0043168174640

Extra Life - Miniature lamps

Tail, direction, parking and indicator lamps
 Feu rouge/clignotant/Feu de position/Répetiteur latéral
 Blink-, Brems- und Schlußlichtlampen
 Lámparas traseras, marcha atrás e indicadores
 Lampade per fanali posteriori, luci di arresto e direzione

1057LFD	1000	P21W	21	BA15s	1/10/200	5	77049	0043168770491
					2/20 blister	5	23284	0043168232845
1056LFD	3000	PY21W	21	BAU15s	1/10/200	6	77091	0043168770910
1077LFD	1000/5000	P21/5W	21/5	BAY15d	1/10/200	7	77050	0043168770507
					2/20 blister	7	23285	0043168232852
TU 1122LFD	1300	P21/4W	21/4	BAZ15d	1/10/200	7	77090	0043168770903
2619LFD	1500	R5W	5	BA15s	1/10/200	8	77051	0043168770514
					2/20 blister	8	23286	0043168232869
TU 2641LFD	1600	R10W	10	BA15s	1/10/200	8	77052	0043168770521
TU 7546LFD	3000	C5W	5	SV8,5	1/10/200	9	77054	0043168770545
					2/20 blister	9	23308	0043168233088
TU 930FD	1500	W5W	5	W2,1x9,5d	1/10/200	10	77048	0043168770484
					10/200	10	70244	0043168702447
TU 2662LFD	1500	T4W	4	BA9s	1/10/200	11	77059	0043168770590
					2/20 blister	11	23292	0043168232920
TU 52830LFD	1000	H6W	6	BAX9s	1/10/100	12	77053	0043168770538

* Tc (hour) is the time up to which 63,2 % of tested lamps have ended their lives. Measured according to GE life test specification. The life of the lamp is sensitive to the operation voltage of the car, 1% of change of the voltage results in 12-15% change of life with opposite sign.

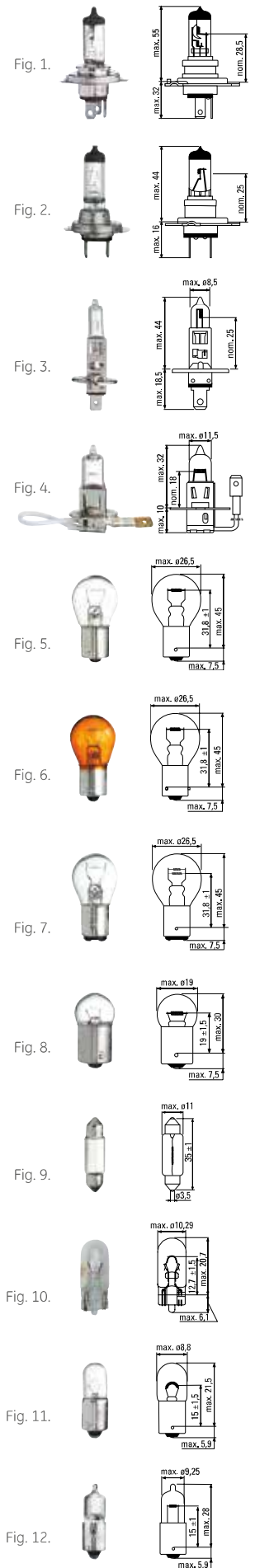



UK High wattage headlight and foglight lamps for OFF ROAD use only

FR Lampes phares et anti-brouillard à haute puissance pour l'utilisation 'OFF-ROAD'

DE Hochwattscheinwerfer- und Nebelscheinwerferlampen die speziell für „OFF ROAD“ oder als „RALLYLAMPEN“ genutzt werden können.

ES Faros delanteros y luces anti-neblia de alta potencia para uso exclusivo EN VÍAS NO OFICIALES

IT Fari anteriori e fari fendinebbia ad alto wattaggio esclusivamente per uso OFF ROAD



Type	ECE	W			Fig.	SKU	EAN
------	-----	---	--	--	------	-----	-----

Rally - Halogen headlight lamps

Headlight lamps – Rally types are not allowed on public roads
 Lampes principales RALLYE – Lampes rallye UTILISATION SUR ROUTE INTERDITE
 Hauptscheinwerferlampen – Rallye-Typen sind im Bereich der StVZO nicht zugelassen
 Lámparas de faro y proyector - halógena – Las lámparas de rally no están permitidas en vías públicas
 Lampade per proiettori - Alogene – E' vietato l'impiego di lampade "Rally" su strade pubbliche

52140U	100	P14,5s	1/10/100	1	34874	9004102348740
			1/10 blister	1	35434	0043168354349
50370U	100	P14,5s/R	1/10/100	1	34875	9004102348757
52130U	100	Pk22s	1/10/200	2	34876	9004102348764
			1/10 blister	2	37963	0043168379632
52100HU	100/80	P43t	1/10/100	3	35974	0043168359740
52100HU	100/90	P43t	1/10/100	3	18195	0043168181952
52670HU	140/100	P43t	1/10/100	3	95413	0043168386654
52030U	100/80	P45t	1/10/100	4	35975	0043168359757

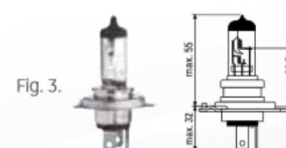
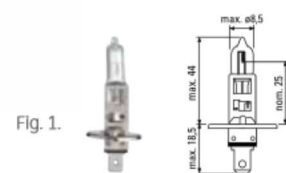

Adjustable LED Daytime Running Lamp

Maximum visibility
instantly

What is DRL

DRL: Daytime Running Lights Lamps are an **automotive lighting device**. They are mounted in pairs on the front of a motor vehicle and are **constantly switched on while driving**. The device is designed to illuminate a well-defined light pattern in order to **improve vehicle visibility** during daylight conditions.

Why DRL

Many countries have encouraged or required daytime use of low-beam headlamps. After 2011 In EU all new car platforms will come with dedicated DRL units. **Existing car owners have the option to install DRL units** available on the aftermarket to increase vehicle conspicuity, **utilizing these instead of the required low beams**. Adding daytime light to **existing cars** is beneficial from many aspects: safety, environment, fuel consumption.

LED DRLs to beam use as DRL

- Designed for DRL function
- Energy efficient
- Excellent visibility
- Long life - up to 10x longer operating time when compared to standard Halogen systems



SKU	Description	Pack structure	EAN code
70331	GE LED AUTO DRL31	1/4 (set)	0043168703314



Headlight lamps – upper and lower beam
 Lampes principales
 Hauptscheinwerferlampen
 Lámparas de faro
 Lampade per proiettori – abbagliante ed anabbagliante



50440MCU	480	H4	60/55	P43t	1/20	1	84489	0043168844895
58520MCU	250	H7	55	PX26d	1/20	2	84491	0043168844918
Megalight +120 Motorcycle - Halogen headlight lamps								
50440SNU	250	H4	60/55	P43t	1/20	3	98714	0043168987141
58520SNU	250	H7	55	PX26d	1/20	4	98715	0043168987158
53110SNU	250	H11	55	PGJ19-2	1/20	5	98713	0043168987134
Sportlight +50 Motorcycle – Halogen headlight lamps								
50440SPU	480	H4	60/55	P43t	1/20	6	98716	0043168987165
58520SPU	250	H7	55	PX26d	1/20	7	98717	0043168987172
53110SPU	250	H11	55	PGJ19-2	1/20	8	98766	0043168987660

* Tc (hour) is the time up to which 63,2 % of tested lamps have ended their lives. Measured according to GE life test specification. The life of the lamp is sensitive to the operation voltage of the car, 1% of change of the voltage results in 12-15% change of life with opposite sign.

Multicolor Motorcycle lamps

Visibly different - see and be seen with our distinctive colour

- unique color that makes you more conspicuous than the rest of the traffic
- up to 30% more light on the road

Clear light Ultra 120 lamps for motorcycle use

Turn night into day

- New level of performance and safety
- Up to 120% more light on the road

Spotlight 120 lamps for motorcycle use

Highlight the road ahead

- Intense Blue white light
- Up to 50% more light on the road

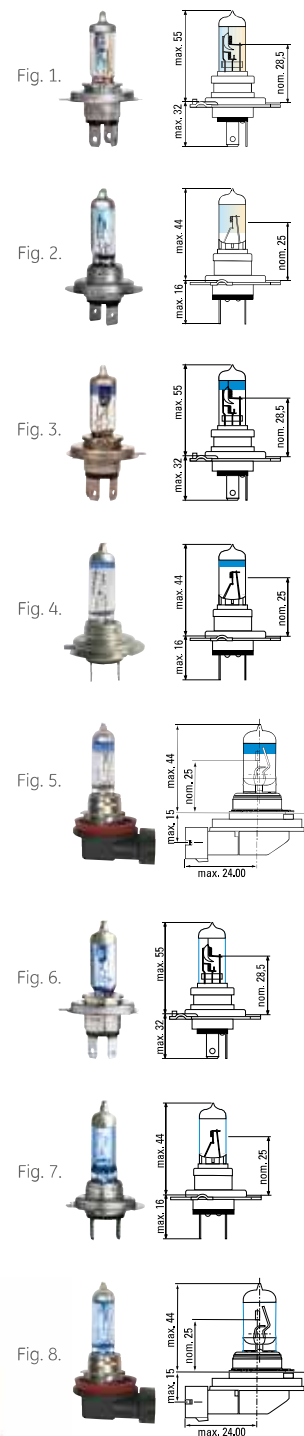

Type	ECE	W			Fig.	SKU	EAN
Headlight lamps - upper and lower beam Lampes principales Hauptscheinwerferlampen Lámparas de faro Lampade per proiettori - abbagliante ed anabbagliante							
H4	50440U	H4	60/55	P43t	1/10/100	1 34454	9004102344544
					1/10 blister	1 17120	0043168354417
					2/20 blister	1 35930	0043168359306
	52070U		60/55	P45t	1/10/100	2 19762	0043168197625
H1	50310/1U	H1	55	P14,5s	1/10/100	3 20727	9004102207276
					1/10 blister	3 17119	0043168354301
H3	50340U	H3	55	Pk22s	1/10/200	4 20729	9004102207290
					1/10 blister	4 17117	0043168354325
H7	58520U	H7	55	PX26d	1/10/100	5 35017	0043168350174
					1/10 blister	5 17123	0043168354356
H8	53090HU	H8	35	PGJ19-1	1/10/100	6 92563	0043168925631
					1/10 blister	6 18254	0043168182546
H9	53100HU	H9	65	PGJ19-5	1/10/100	7 92565	0043168925655
					1/10 blister	7 18256	0043168182560
H11	53110HU	H11	55	PGJ19-2	1/10/100	6 92567	0043168925679
					1/10 blister	8 60957	0043168609579
HB3	53060U	HB3	60	P20d	1/10/100	8 36474	0043168364744
					1/10 blister	8 18266	0043168182669
HB4	53070U	HB4	51	P22d	1/10/100	9 36472	0043168364720
					1/10 blister	9 18267	0043168182676
H10	53080U	H10	42	PY20d	1/10/100	9 12905	0043168129053
R2	52950	R2 Halogen	45/40	P45t	1/10/100	10 35077	9004102350774
HIR 2	54430U	HIR 2	55	PX22d	1/6/48	11 96484	0043168964845

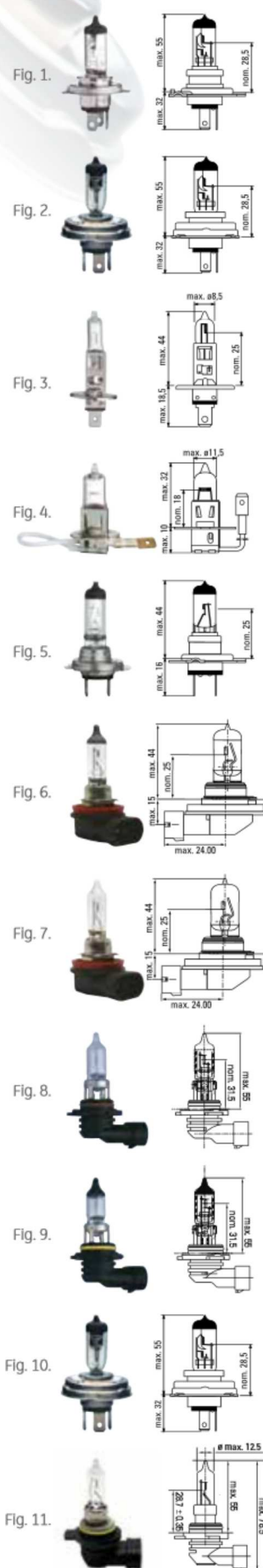

Miniature lamps

- side signals
- parking lamps
- stop lamps
- fog lamps
- license plate
- reverse lamps
- parking lamps
- dashboard lamps
- interior lamps
- indicator lamps
- side return signal lamps

Upgrade your car with
GE premium lamps

Extra Life

better economy for daytime lighting, 2x longer life

SportLight

when you really want to see and be seen

Early Star

GE "Reliable" range

quality-performance
fully replacable with OEM lamps



P21



P21



P21





					
					
●	●	●	●	●	●
	●	●		●	
●	●	●	●		
●	●	●	●	●	●

Type	ECE	W			Fig.	SKU	EAN
Tail, stop and direction lamps Feu rouge/stop/clignotant Brems-, Blink- und Schlußlichtlampen Lámparas traseras, freno e intermitente Lampade per fanali posteriori, luci di arresto e direzione							
1056	PY21W	21	BAU15s	1/10/200	1	37964	0043168379649
				10/200	1	17248	9004102328193
				2/20 blister	1	17133	0043168354073
1057	P21W	21	BA15s	1/10/200	2	37894	0043168378949
				10/200	2	17218	9004102238058
				2/20 blister	2	17131	0043168354066
1058	P21W	21	BA15d	10/200	3	17219	9004102349914
1156		32 CP	BA15s	10/200	2	77369	0043168773690
1077	P21/5W	21/5	BAY15d	1/10/200	5	37896	0043168378963
				10/200	5	17228	9004102238096
				2/20 blister	5	17130	0043168354097
1098		20/5	BA15d	10/200	5	27736	0043168277365
1122	P21/4W	21/4	BAZ15d	10/200	5	17241	9004102238546
				2/20 blister	5	35931	0043168359313
1157	1157 ANSI	32/3 CP	BAY15d	10/200	5	17247	0043168357197
				2/20 blister	5	37969	0043168379694
7440	W21W	21	W3x16d	1/10/100	6	93458	0043168934589
				2/20 blister	6	93447	0043168934473
7440NA	WY21W	21	WX3x16d	1/10/100	7	76090	0043168760904
				2/20 blister	7	76091	0043168760911
7443	W21/5W	21/5	W3x16q	1/10/100	8	93448	00 43168934480
				2/20 blister	8	512863	5994101128631
53990	H21W	21	BAY9S	10/200	9	94714	0043168947145

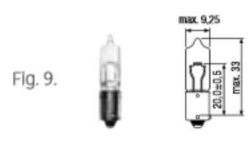
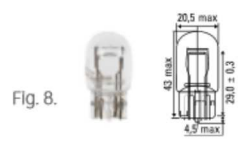
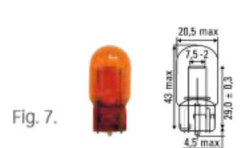
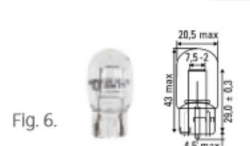
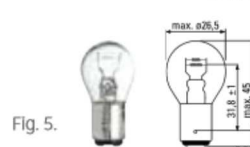
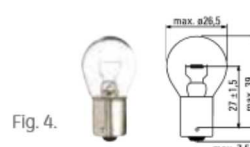
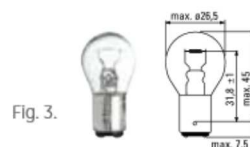
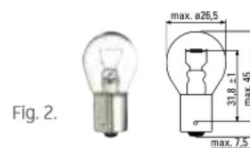
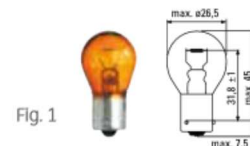

Type	ECE	W			Fig.	SKU	EAN
------	-----	---	--	--	------	-----	-----

Interior lamps
Lampes éclairage interieur
Lampen für Innenbeleuchtung
Lámparas de interior
Lampade per illuminazione interna

7546	C5W	5	SV8,5-8	1/10/200	1	37912	0043168379120
				10/200	1	27771	9004102238409
				2/20 blister	1	17129	0043168354608
91701		3	SV7	10/200	2	73599	0043168936668
7575		5	SV8,5-8	1/10/200	3	38805	0043168388054
				10/200	3	27781	0043168379557
				2/20 blister	3	37956	0043168379564
7576	DIN 72601K	10	SV8,5-8	1/10/200	3	37913	0043168379137
				10/200	3	27793	9004102238683
				2/20 blister	3	35463	0043168354639
91715		10	SV8,5-8	10/200	5	73600	0043168387781
91735		10	SV8,5-8	10/200	4	73598	0043168132541
				1/10/200	4	93436	0043168379908
7592		15	SV8,5-8	10/200	6	27801	9004102349440
				2/20 blister	6	38803	0043168388030
7593		18	SV8,5-8	10/200	6	27803	9004102349457
7585		10	SV8,5-8	2/20 blister	4	39459	0043168394598

Miniature halogen lamps
Lampes Halogène miniature
Miniatur-Halogenlampen
Lámparas halógenas miniatura
Lampade miniature alogene

58540		5	BA9s	1/20	7	34930	9004102349303
58560		10	BA9s	1/20	7	34926	9004102349266
52830U	H6W	6	BAX9s	1/10/100	8	38849	0043168388498
				1/10 blister	8	38850	0043168388504

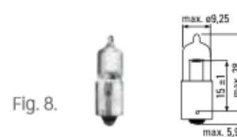

replacable with OEM lamps



Type	ECE	W			Fig.	SKU	EAN
------	-----	---	--	--	------	-----	-----

Tail, direction, parking and indicator lamps
 Feu rouge/clignotant/Feu de position/Répetiteur latéral
 Blink-, Brems- und Schlußlichtlampen
 Lámparas traseras, marcha atrás e indicadores
 Lampade per fanali posteriori, luci di arresto e direzione

2619	R5W	5	BA15s	1/10/200	1	37897	0043168378970
				10/200	1	17253	9004102238270
				2/20 blister	1	17136	0043168353984
2619T	R5W	5	BA15s	10/200	2	20112	0043168201124
2641	R10W	10	BA15s	1/10/200	1	37899	0043168378994
				10/200	1	17256	9004102238348
				2/20 blister	1	17134	0043168354059
2641T	R10W	10	BA15s	10/200	3	20113	0043168201131
2696	DIN 72601J	2	BA7s	10/200	4	27393	9004102349242
				2/20 blister	4	38855	0043168388559
2656		3	BA9s	10/200	5	26741	0043168936927
2660		2	BA9s	10/200	5	26742	9004102349358
				2/20 blister	5	37960	0043168379601
2662	T4W	4	BA9s	1/10/200	6	37900	0043168379007
				10/200	6	27347	9004102238379
				2/20 blister	6	17137	0043168354509
5301		1,2	W2x4,6d	1/10/200	7	42804	0043168379076
				10/200	7	42799	9004102238669
				2/20 blister	7	35451	0043168354516
91605		2	W2x4,6d	10/200	7	97987	0043168936521
91609 PS*		0,5	W2x4,6d	10/200	8	93678	0043168936781

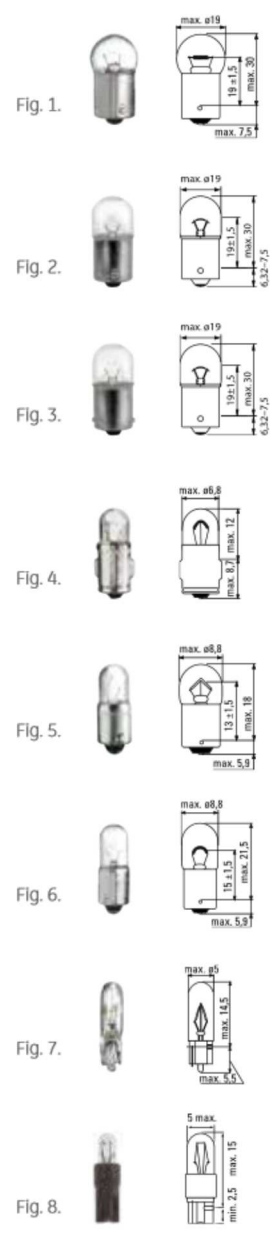

* PS - Plastic cap

Type	ECE	W			Fig.	SKU	EAN
------	-----	---	--	--	------	-----	-----

Wedge base lamps with and without plastic cap
Lampes "wedge base" avec ou sans culot plastique
Glassockellampen mit und ohne Steckfassung
Lámparas con casquillo de vidrio y lámparas con base de plástico
Lampade con attacco vetro e/o in plastica

5301 PS*		1,2	B8,5d	1/10/200	1	93438	0043168379885
				10/200	1	13264	0043168132640
				2/20 blister	1	39462	0043168394628
91641 PS*		1,2	B8,4d	10/200	2	93673	0043168936736
91645 PS*		2	BX8,4d	10/200	3	93656	0043168936569
91646 PS* 14V		1,12	B8,4d	10/200	4	93657	0043168936576
5303 PS*		2	B8,5d	10/200	5	93659	0043168936590
91695 PS* 14V		1,4	HRQ	10/200	6	93664	0043168936644
91696 PS*		1,8	EBS R11	10/200	7	93665	0043168936651
504	W3W	3	W2,1x9,5d	1/10/200	8	41952	0043168379106
				10/200	8	27887	9004102238492
				2/20 blister	8	35452	0043168354523
501	W5W	5	W2,1x9,5d	1/10/200	9	41961	0043168379113
				10/200	9	27888	0043168924580
				2/20 blister	9	17138	0043168354530
501NB	W5W	5	W2,1x9,5d	10/200	10	97387	0043168936552
				2/20 blister	10	93011341	0064894508172
501NA	WY5W	5	W2,1x9,5d	10/200	11	21512	0043168924658
				2/20 blister	11	90199	0043168901994
921	W16W	16	W2,1x9,5d	10/200	12	21513	0043168215138
WY16WNAL	WY16WNAL	16	W2,1x9,5d	10/200	13	93032367	0064894538834
				2/20 blister	13	93032366	0064894538827

* PS - Plastic cap

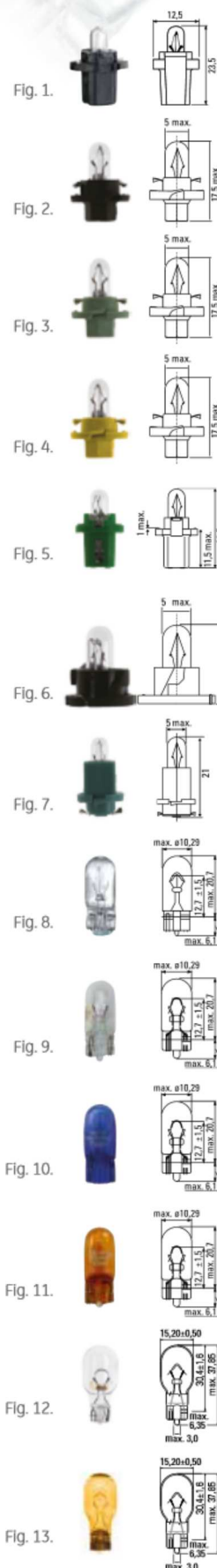

replacable with OEM lamps

Heavy Star



 24-hour lamps with longer life and increased robustness

 Les lampes 24 pour les points lourds avec une durée de vie allongée et une résistance accrue

 24 Lampen für 120W und mehr mit längerer Lebensdauer und höherer Robustheit

 Lámparas de camión de 24 con una duración de vida más larga y una mayor solidez

 Lampare per le pesanti 24 durata di vita e robustezza superiori alle lampare standard



--	--	--	--	--	--	--	--

Heavy Star - Halogen headlight lamps

Headlight lamps - upper and lower beam
 Lampes principales
 Hauptscheinwerferlampen
 Lámparas de faro
 Lampade per proiettori - abbagliante ed anabbagliante

50320/1U_HDL	H1	70	P14,5s	1/10/100	1	61493	0043168614931
50350U_HDL	H3	70	Pk22s	1/10/200	2	61496	0043168614962
50450HDLU	H4	75/70	P43t	1/10/100	3	61494	0043168614948
58521HDLU	H7	70	Px26d	1/10/100	4	61495	0043168614959

Heavy Star - Miniature lamps

Tail, direction, parking and indicator lamps
 Feu rouge/clignotant/Feu de position/Répetiteur latéral
 Blink- und Schlußlichtlampen
 Lámparas traseras, marcha atrás e indicadores
 Lampade per fanali posteriori, luci di arresto e direzione

1060HDL	P21W	21	BA15s	10/200	5	77095	0043168770958
				2/20 blister	5	99604	0043168996044
1061HDL	P21W	21	BA15d	10/200	6	77097	0043168770972
1073HDNAL	PY21W	21	BAU15s	10/200	7	77329	0043168773294
2627HDL	R5W	5	BA15s	10/200	8	77334	0043168773348
2643HDL	R10W	10	BA15s	10/200	9	77342	0043168773423
2661HDL	T4W	4	BA9S	10/200	10	61485	0043168614856
				2/20 blister	10	99605	0043168996051

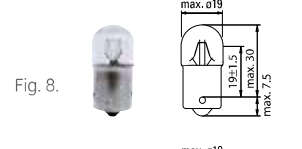
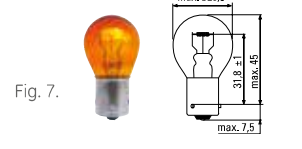
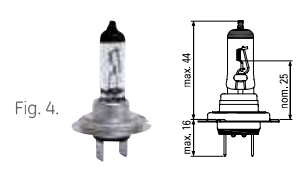
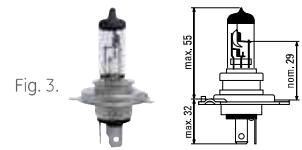
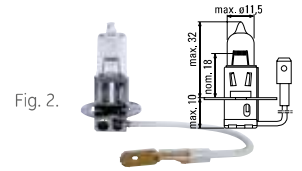
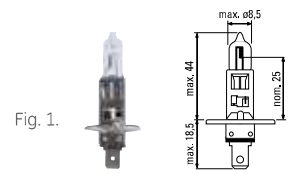

Type	ECE	W			Fig.	SKU	EAN
------	-----	---	--	--	------	-----	-----

Headlight lamps – upper and lower beam
Lampes principales
Hauptscheinwerferlampen
Lámparas de faro
Lampade per proiettori – abbagliante ed anabbagliante

H1	50320/1U	H1	70	P14,5s	1/10/100	1	23793	9004102237938
H3	50350U	H3	70	Pk22s	1/10/200	2	21149	9004102211495
	50400U Rally*		100	Pk22s	1/10/200	2	38659	0043168386593
H4	50450HU	H4	75/70	P43t	1/10/100	3	38836	9004102237402
	52080	H4	75/70	P45t	1/10/100	3	43066	9004102237471
	52710HU Rally*		100/70W	P43T	1/10/100	3	94938	0043168386647
H7	58521U	H7	70	Px26d	1/10/100	5	38838	0043168388382

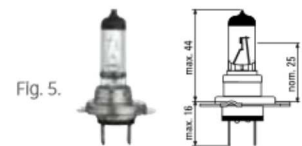
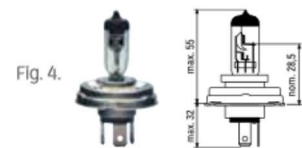
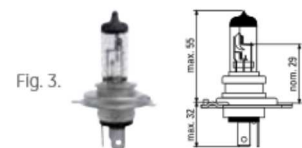
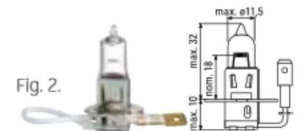
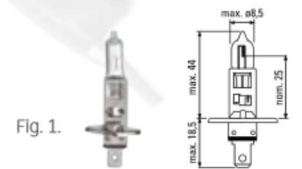

Rally* - OFF ROAD use only

Type	ECE	W			Fig.	SKU	EAN
------	-----	---	--	--	------	-----	-----

Tail, direction, parking and indicator lamps
 Feu rouge/clignotant/Feu de position/Répétiteur latéral
 Blink-, Brems- und Schlußlichtlampen
 Lámparas traseras, marcha atrás e indicadores
 Lampade per fanali posteriori, luci di arresto e direzione

1060HD*	P21W	21	BA15s	1/10/200	1	37895	0043168378956
				10/200	1	17222	9004102348849
1061HD*	P21W	21	BA15d	10/200	2	17225	9004102349921
2626HD*	R5W	5	BA15d	10/200	3	17309	9004102349983
2627HD*	R5W	6	BA15s	1/10/200	4	37898	0043168378987
				10/200	4	17311	9004102349396
2643HD*	R10W	10	BA15s	1/10/200	5	37958	0043168379588
				10/200	5	17313	9004102349402
2661HD*	T4W	4	Ba9s	10/200	6	27341	9004102349334



* Supported Heavy Duty (HD) lamps
 Lampes renforcées (anti vibration)
 Heavy-Duty-Lampen
 Lámparas reforzadas HD
 Lampade rinforzate HD

replacable with OEM lamps

Type	ECE	W			Fig.	SKU	EAN
Tail, direction, parking and indicator lamps Feu rouge/clignotant/Feu de position/Répetiteur latéral Blink-, Brems- und Schlußlichtlampen Lámparas traseras, marcha atrás e indicadores Lampade per fanali posteriori, luci di arresto e direzione							
2626	R5W	5	BA15d	10/200	1	17308	9004102349990
2627	R5W	5	BA15s	10/200	2	17310	9004102238294
2643	R10W	10	BA15s	10/200	3	17312	9004102238355
2692	DIN 72601J	3	BA7s	10/200	4	27380	9004102349259
2661	T4W	4	BA9s	10/200	5	27327	9004102238393
2663		2	BA9s	10/200	6	27355	9004102349341
91602		1,2	W2x4,6d	10/200	7	65718	0043168132565
				1/10/200	7	65717	0043168379816
5302PS*		1,2	B8,5d	1/10/200	8	93442	0043168387774
				10/200	8	13269	0043168132695
91693		1,2	EBS R11	10/200	9	93662	0043168936620
5305	W3W	3	W2,1x9,5d	1/10/200	10	97226	0043168387767
				10/200	10	65830	0043168132619
91622	W5W	5	W2,1x9,5d	10/200	10	65680	0043168936545

* PS - Plastic cap

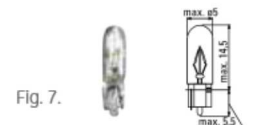
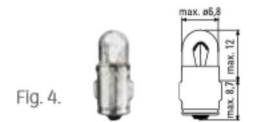

Type	ECE	W			Fig.	SKU	EAN
------	-----	---	--	--	------	-----	-----

Interior lamps
Lampes éclairage interieur
Lampen für Innenbeleuchtung
Lámparas de interior
Lampade per illuminazione interna

7552	C5W	5	SV8,5-8	10/200	1	27773	9004102238454
91716		10	SV8,5-8	10/200	1	73601	0043168936699
7579		5	SV8,5-8	10/200	2	27788	0043168388061
7580		10	SV8,5-8	10/200	2	27795	9004102349419
7594		15	SV8,5-8	10/200	3	27802	0043168388078
7595	DIN 72601K	18	SV8,5-8	10/200	3	27806	0043168388092



Tail, stop and direction lamps
Feu rouge/Stop/Clignotant
Rücklicht-, Brems- und Schlußlichtlampen
Lámparas traseras, freno e intermitente
Lampade pe fanali posteriori, luci di arresto e direzione

1115		15	BA15s	10/200	4	17238	0043168387422
1117	DIN 72601R	18	BA15s	10/200	4	17240	0043168387446
1060	P21W	21	BA15s	10/200	5	17221	9004102238072
1061	P21W	21	BA15d	10/200	6	17223	9004102349938
1073	PY21W	21	BAU15s	10/200	7	17250	9004102344520
1078	P21/5W	21/5	BAY15d	1/10/200	8	38731	0043168387316
				10/200	8	17232	9004102238133
				2/20 blister	8	38727	0043168387279
54400	H21W	21	BAY9S	10/200	9	94715	0043168947152

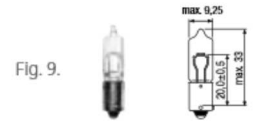

replacable with OEM lamps

Lamp kits

Premium "QUAD kits"

CONTENT		SKU	EAN
2XH4 Megalight Ultra +90 + 2X 501NB W5W	1/10	99627	0043168996273
2XH7 Megalight Ultra +90 + 2X 501NB W5W	1/10	99628	0043168996280
2XH1 Megalight Ultra +90 + 2X 501NB W5W	1/10	99629	0043168996297
2XH4 Sportlight+50 + 2X 501NB W5W	1/10	99666	0043168996662
2XH7 Sportlight+50 + 2X 501NB W5W	1/10	99667	0043168996679
2XH1 Sportlight+50 + 2X 501NB W5W	1/10	99668	0043168996686



Emergency Kits

Coffrets de Secours

Ersatzdose

Estuche de repuesto

Scatola lampade di scorta

CONTENT		SKU	EAN
H4, PY21W, P21/5W, P21W, R5W, C5W, W5W, T4W, normal fuses 10A, 15A, 20A, mini fuses 7,5A, 10A, 20A	1/10	70693	0043168706933
H1, PY21W, P21/5W, P21W, R5W, C5W, W5W, T4W, normal fuses 10A, 15A, 20A, mini fuses 7,5A, 10A, 20A	1/10	70706	0043168707060
H7, PY21W, P21/5W, P21W, R5W, C5W, W5W, T4W, normal fuses 10A, 15A, 20A, mini fuses 7,5A, 10A, 20A	1/10	70694	0043168706940
H1+H7, PY21W, P21/5W, P21W, R5W, C5W, W5W, T4W, normal fuses 10A, 15A, 20A, mini fuses 7,5A, 10A, 20A	1/10	70707	0043168707077
24V H1+H7, PY21W, P21/5W, P21W, R5W, C5W, W5W, T4W, normal fuses 10A, 15A, 20A, mini fuses 7,5A, 10A, 20A	1/10	96754	0043168967549
H1, P21/5W, P21W, R5W, C5W, fuses 10A, 15A, 20A	1/10	92751	0043168927512
H4, P21/5W, P21W, R5W, C5W, fuses 10A, 15A, 20A	1/10	92752	0043168927529
H7, P21/5W, P21W, R5W, C5W, fuses 10A, 15A, 20A	1/10	92753	0043168927536
H1+H7, P21/5W, P21W, R5W, C5W, fuses 10A, 15A, 20A	1/10	92755	0043168927550



Displays

GE wall displays Vacuum formed plastic body and positions for boxes, foam insert for miniature lamps

Defined content for 161 lamps - main halogens and miniatures. Shipped as empty (sku 88653) or filled (sku 82881).



Defined content for 121 lamps - main halogens and miniatures. Shipped as empty (sku 98416).



GE wall cupboards Vacuum formed plastic body, including lamp tester



Defined content for 591 lamps - main halogens and miniatures. Shipped as empty (sku 64983) or filled (sku 65234).



Defined content for 680 lamps main halogens and miniatures. Shipped as empty (sku 98417).

GE wall or counter display

Type	Code
Empty display	75040
Sportlight	75041
Megalight Ultra	75042

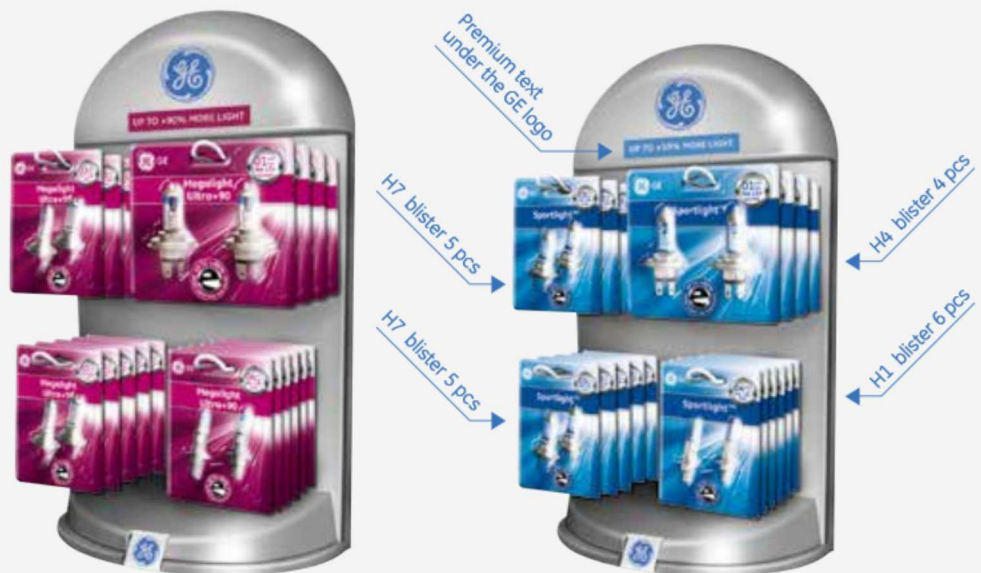

Packaging

Etikettage – Verpackung – Etiqueta – Etichetta

GE auto aftermarket retail packaging concept

GE Lighting – has been a leading supplier to Automotive OEM and Aftermarket customers throughout the world for many decades. We continue our pioneering work to offer advanced solutions and benefits that can fulfill our customers' needs.

Our brand is the symbol of our heritage, and of the quality and trust we have delivered to our customers. It embodies our commitment to anticipate and meet their changing needs. It represents the imagination we use to address those needs in a manner that reflects our values.

As a result of continuous efforts to fulfill our customers' changing needs - GE has developed the aftermarket packaging concept. The main objective of our redesigned packaging is to enhance the shopping experience and drive upsell.

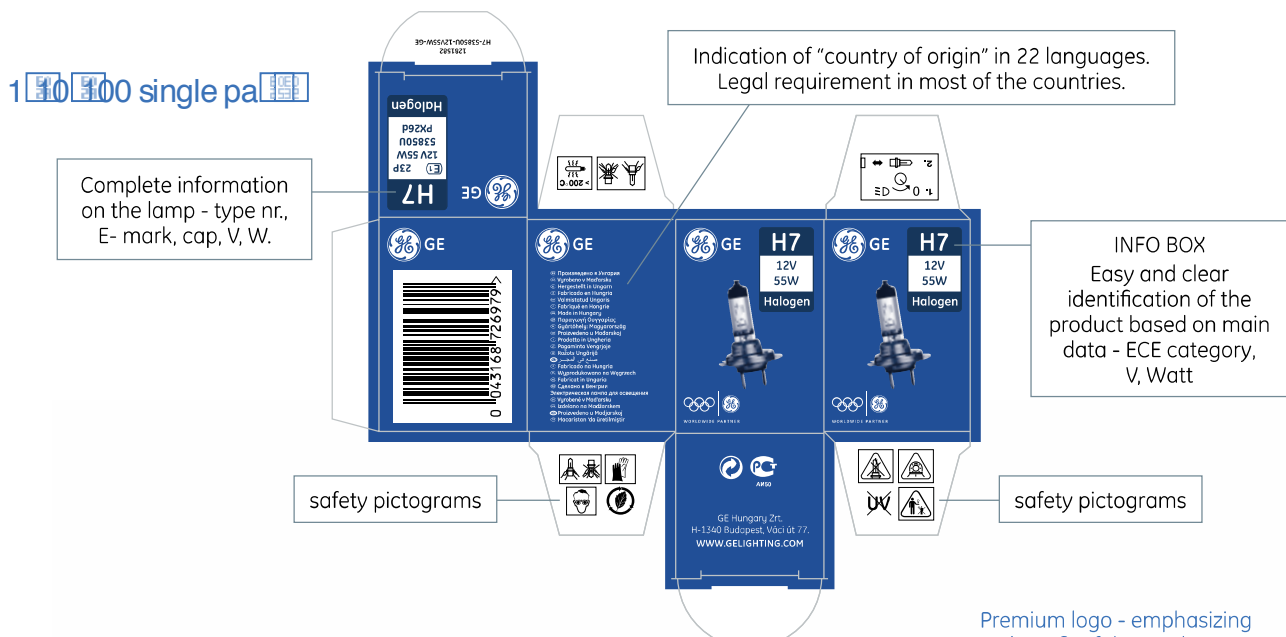

Twinklax display pack



Translation of the premium feature/benefit explanation in 11 languages.

10 Way pack



GE Blister

Our redesigned blister pack has the following advantages:

GLOBAL: packages reflect a "world view", display the elements of environmental and regulatory requirements, use multiple languages

TRUSTED: make the purchase easier and clearer, simplified messaging that is repeated on all platforms

PRECISE: package information is clear and states features prominently

APPROACHABLE, SIMPLE: Easy to understand and right for the purchaser, helping them to decide which product is good for them. Provides differentiation between standard range and premium ranges by using color coding.



Colour coded packages tied directly to POS messaging for easy identification:

STANDARD range - describe the standard categories, D2 discharge, 12V-24V halogen and miniature lamps

PREMIUM range with feature/benefit logo, explain how one product differs from another, and why it is most appropriate for its task - rationalize the move to upsell in the halogen and miniature lamp categories

Standard ranges

- D2 gas discharge lamps
- 12V halogen and miniature lamps
- 24V halogen and miniature lamps















Premium ranges

- Megalight ultra +120
- Megalight ultra +90
- Megalight plus 50
- Sportlight
- Extra life
- Heavy Star
- Rally
- Motorcycle

GE Blister range

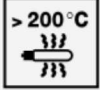
Product Code	Type	Designation	Simplified number	Lamp in blister	Wattage	Volt	EAN code
17119	50310U	H1	04	1	55W	12V	0043168354301
19758	50310MPU	H1 Megalight Plus 50	04MPU	2	55W	12V	0043168197588
96948	50310XU	H1 Megalight Ultra - Plus 90	04XU	2	55W	12V	0043168969482
98266	50310NU	H1 Megalight Ultra - Plus 120	04NU	2	55W	12V	0043168982665
19685	50310LU_DPU	H1 Extra Life	04DPU	2	55W	12V	0043168196857
73343	50310NHSU	H1 Sportlight	04NHSU	2	55W	12V	0043168908344
93012845	50310SBU	H1 Sportlight Ultra	04SBU	2	55W	12V	0064894521805
35434	52140U	H1 Rally - offroad	104	1	100W	12V	0043168354349
38679	50320U	H1	74	1	70W	24V	0043168386791
17117	50340U	H3	05	1	55W	12V	0043168354325
37963	52130U	H3 Rally - offroad	105	1	100W	12V	0043168379632
38674	50350U	H3	75	1	70W	24V	0043168386746
17123	58520U	H7	03	1	55W	12V	0043168354356
97131	58320NHSU	H7 Sportlight	03NHSU	2	55W	12V	0043168887892
93012861	58520SBU	H7 Sportlight Ultra	03SBU	2	55W	12V	0064894521904
19759	58520MPU	H7 Megalight Plus 50	03MPU	2	55W	12V	0043168197595
74154	58520SXU	H7 Megalight Ultra - Plus 90	03SXU	2	55W	12V	0043168741545
98282	58520SNU	H7 Megalight Ultra - Plus 120	03SNU	2	55W	12V	0043168982825
19686	58520LU_DPU	H7 Extra Life	03DPU	2	55W	12V	0003168196864
45691	58521U	H7 24V	77	1	70W	24V	0043168456913
17120	50440U	H4	01	1	60/55W	12V	0043168354417
35930	50440U	H4	01	2	60/55W	12V	0043168359306
91579	50450U	H4	71	1	60/55W	24V	0043168915793
93361	50440MPU	H4 Megalight Plus 60	01MPU	2	60/55W	12V	0043168933612
74153	50440SXU	H4 Megalight Ultra - Plus 90	01SXU	2	60/55W	12V	0043168741538
98281	50440SNU	H4 Megalight Ultra - Plus 120	01SNU	2	60/55W	12V	0043168982818
19682	50440LU_DPU	H4 Extra Life	01DPU	2	60/55W	12V	0043168196826
97132	53800NHSU	H4 Sportlight	01NHSU	2	60/55W	12V	0043168887908
93012846	50440SBU	H4 Sportlight Ultra	01SBU	2	60/55W	12V	0064894521812
18266	53060U	HB3	07	1	60W	12V	0043168182669
18267	53070U	HB4	09	1	51W	12V	0043168182676
18254	53090U	H8	13	1	35W	12V	0043168182546
18256	53100U	H9	15	1	65W	12V	0043168182560
60957	53110U	H11	16	1	55W	12V	0043168609579
17131	1057	P21W	21	2	21W	12V	0043168354066
23284	1057LFD	P21W Extra Life	21D	2	21W	12V	0043168232845
99604	1060HDL	P21W Heavy Star	81HDL	2	21W	24V	0043168996044
17130	1077	P21/5W	23	2	21/5W	12V	0043168354097
23285	1077LFD	P21/5W Extra Life	23D	2	21/5W	12V	0043168232852
38727	1078	P21/5W	93	2	21/5W	24V	0043168387279
38728	1098	20/5W	48	2	20/5W	12V	0043168387286
35931	1122	P21/4W	20	2	21/4W	12V	0043168359313
37969	1157	1157 ANSI	39	2	32/3W	12V	0043168379694
17133	1056	PY21W	22	2	21W	12V	0043168354073
17136	2619	R5W	24	2	5W	12V	0043168353984
23286	2619LFD	R5W Extra Life	24D	2	5W	12V	0043168232869
17137	2662	T4W	26	2	4W	12V	0043168354509
23292	2662LFD	T4W Extra Life	26D	2	4W	12V	0043168232920
17134	2641	R10W	30	2	10W	12V	0043168354059
37960	2660	2660	38	2	2W	12V	0043168379601
99605	2661HDL	T4W Heavy Star	86HDL	2	4W	24V	0043168996051
38855	2696	72601J	47	2	2W	12V	0043168388559
39462	5301PS	W1,2W	60	2	1,2W	12V	0043168394628
35451	5301	W1,2W	29	2	1,2W	12V	0043168354516
35452	5304	W3W	27	2	3W	12V	0043168354523
17138	501	W5W	28	2	5W	12V	0043168354530
90199	501A	WY5W	33	2	5W	12V	0043168901994
93011341	501NB	W5W	28	2	5W	12V	0064894508172
17129	7546	C5W	25	2	5W	12V	0043168354608
23308	7546LFD	C5W Extra Life	25D	2	5W	12V	0043168233088
37956	7575	7575	40	2	5W	12V	0043168379564
35463	7576	DIN 72601K	31	2	10W	12V	0043168354639
39459	7585	7585	32	2	10W	12V	0043168394598
38803	7592	72601K	42	2	15W	12V	0043168388030
38850	52830	H6W	62	1	6W	12V	0043168388504
93447	7440	W21W	50	2	21W	12V	0043168934473
512863	7443	W21/5W	49	2	21/5W	12V	5994101128631
76091	7440NA	WY21W	51	2	21W	12V	0043168760911
93032366	WY16WNAL	WY16WNAL	52	2	16W	12V	0064894538827

Symbols used on the packaging

						
Do not touch with bare fingers	No disposal of as household waste	For removal and installation use appropriate eye protection	Dangerous voltage	Installation and servicing of electronic device only by qualified electrical employees	For removal and installation use appropriate gloves	Read attached instructions before use
						
Operation only in luminaire installations with protective shield	Don't let children play with bulbs	No operation of lamps with scratched or damaged glass bulb	Beware of temperature	Switch off light before re-lamping	Not suitable for household use	Use as vehicle lamp 12V or 24V

Base stamps on the GE automotive lamps

Halogen auto lamp marking

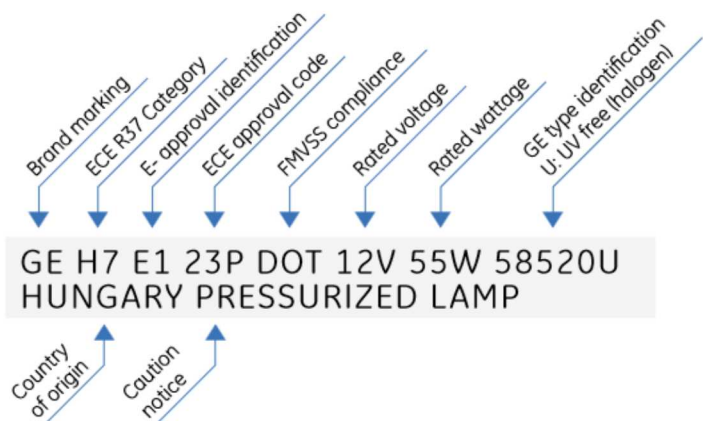

Miniature auto lamp marking

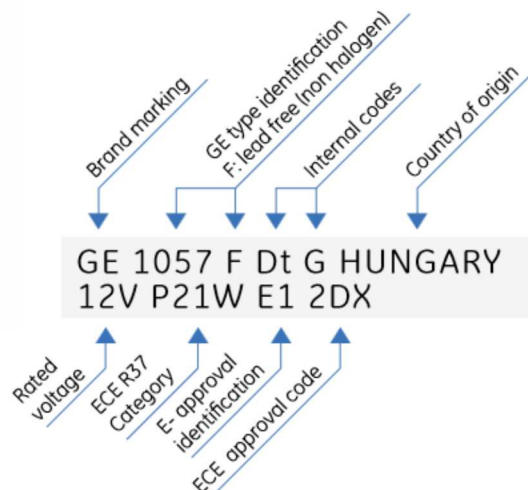

Lamp bases

ulot – So elü ersi nt – as uillos de lá paras – tra ni la pade



BA7s

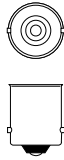

BA9s



BA15s



BAU15s



BA15d

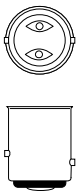

BAY15d

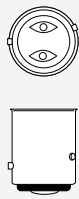

BAZ15d

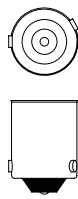

BAX9s



P14,5s/R

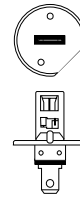

P14,5s

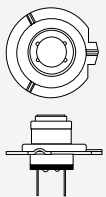

PX26d

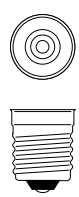

E10

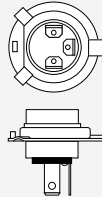

P43t



P45t

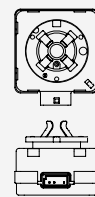

PK32d-2

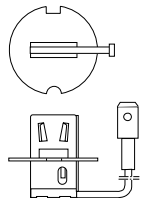

PK22s

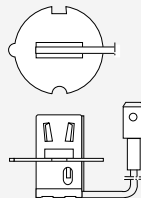

PK22s/R



SV8,5



P32d-2

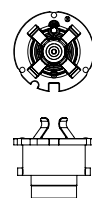

P32d-3

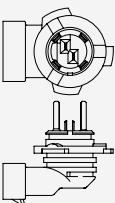

PY20d

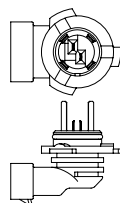

P20d

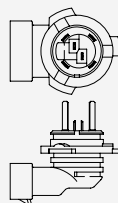

P22d



W2,1x9,5d



W2x4,6d

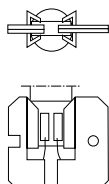

X511

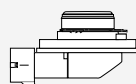

PGJ19

ALBANIA, MACEDONIA

VSD Merkur d.o.o
Exclusive Sales Representative of
GE Hungary Kft.
Str. Vasil Glavinov 7b/3
1000 Skopje
Macedonia
Tel: (389) 2 324 4790

ARGENTINA, PARAGUAY, URUGUAY

GE Consumer & Industrial Argentina S.A.
Nicolás de Vedia 3616, piso 6o
Edificio DOT – (C1430DAH)
Buenos Aires
Argentina
CUIT: 30-67992375-3
Centro de atención al cliente:
0810 122 GECI (4324)

AUSTRALIA

GE Lighting Australia Pty Ltd
32 Phillip Street,
Parramatta, NSW, 2150
Australia
Tel: (61) 298 066 619

BRAZIL

GE Iluminação do Brasil CENESP
Av. Maria Coelho Aguiar,
215 Bloco C, 6°. andar, Jd São Luiz
São Paulo, SP, 05804-900
Brazil
Tel: (55) 11 3614 1700
Fax: (55) 11 3614 1825

BULGARIA

VSD Merkur e.o.o.d
Exclusive Sales Representative
of GE Hungary Kft.
Str. 2 Nikolai Haitov 4/31
1113 Sofia
Bulgaria
Tel: (359) 2 870 5586

CANADA

GE Lighting Canada
2300 Meadowvale Blvd
Mississauga, ON L5N 5P9,
Canada
Tel: (1) 905 858 6724
Fax: (1) 905 8586602

CHILE, BOLIVIA

General Electric de Chile S.A.
Av. Isidora Goyenechea 2800,
Las Condes – Edificio Titanium, Piso 21
75500647 Santiago
Chile
Tel: (56) 2 2652 6500

CHINA

GE Asia Headquarters
GE Lighting Co.,Ltd.
7 floor, Building 1, No.1. Hua Tuo Rd.
Zhang Jiang Hi-Tech Park
Pudong, Shanghai 201203
China
Tel: (86) 21 3877 7888
Fax: (86) 21 3877 7437

COLOMBIA, ECUADOR

GE International Inc. Sucursal Colombia
Avenida Carrera 72 No. 80-94, Piso 12.
Centro Empresarial Titan Plaza
Bogota D.C.
Colombia
Tel: (57) 1 742 5660
Fax: (57) 1 742 5569

CZECH REPUBLIC, SLOVAKIA

GE International, Inc.
Bucharova 2641/14
158 00 Praha 5
Czech Republic
Tel: (420) 602 115 021

DENMARK

GE Lighting A/S
Park Alle 295
2605 Brøndby
Denmark
Tel: (45) 8040 4945
Fax: (45) 8040 4947

FINLAND

GE consumer and Industrial Oy
Kuortaneenkatu 2, 5krs PL 620,
00031 GE – Helsinki
Finland
Tel: (358) 10394 2507

FRANCE, BELGIUM, LUXEMBOURG

GE Lighting SAS
Paris Nord II - 13. rue de la Perdrix
B.P. 56073, Tremblay en France
95947 ROISSY
Charles de Gaulle Cedex
France
Tel: (33) (0) 1 48 63 68 00
Fax: (33) (0)1 48 63 68 08

GERMANY, AUSTRIA, SWITZERLAND, NETHERLANDS

GE Lighting GmbH
Bleichstrasse 64-66
60313 Frankfurt/M.
Germany
Tel: (49) 69 40125 1383
Fax: (49) 69 40125 1393

HONG KONG

GE International Operations Co. Inc.
8th Floor, Lee Garden One
33 Hysan Avenue Causeway Bay
Hong Kong
Tel: (852) 2100 6800
Fax: (852) 2376 0013

HUNGARY, GREECE, CYPRUS, MALTA

GE Hungary Kft.
1044 Budapest
Váci út 77.
Hungary
Tel: (36) 1 399 1466
Fax: (36) 1 399 2577

INDIA, SRI LANKA

GE India Industrial Pvt Ltd.
73/1, 7th Floor, Summit B Brigade
Metropolis, Garudacharpalya
Mahadevapura Post Bangalore
560048 Karnataka
India
Tel: (91) 80 4930 8000
Fax: (91) 80 4930 8800/ 4930 8027

INDONESIA

PT.GE Lighting Indonesia
BRI II Tower, 27th Floor
Jl. Jend Sudirman Kav.
44-46 Jakarta 10210
Indonesia
Tel: (62) 21 573 0500
Fax: (62) 21 574 5241

ITALY

GE Lighting Srl
Centro Direzionale
Colleoni Via Paracelso16
20864 Agrate Brianza (MB)
Italy
Tel: (39) 344 014 14 31
Fax: (39) 800784747

JAPAN

GE Consumer Products Japan, Ltd.
Akasaka Park Bldg.,
5-2-20 Akasaka, Minato-ku,
Tokyo 107-6116
Japan
Tel: (813) 5544 6700
Fax: (813) 5544 6760

KOREA

GE Lighting Korea Ltd.
9F, POBA Gangnam Tower 343,
Hakdong-ro, Gangnam-gu,
Seoul, 135-820,
Korea
Tel: (82) 2 6201 4300
Fax: (82) 2 6201 4344

MALAYSIA

GE Lighting Malaysia
Level 6, 1 Sentral, Jalan Travers
Kuala Lumpur Sentral,
50470 Kuala Lumpur
Malaysia
Tel: (603) 2273 9788

MEXICO, CENTRAL AMERICA & CARIBBEAN

GE Commercial Materials S.de.R.L.
de C.V. Av. Churubusco No 3900
Norte Apartado Postal 216 64517
Monterrey N.L. México
Mexico
Tel: (52) 8 318 5600
Fax: (52) 8 318 5693

MIDDLE EAST, AFRICA & PAKISTAN

GE International Inc.
U-Bora Tower Business Bay
P.O. Box 11549, Dubai
UAE
Tel: (971) 4 4299 666
Fax: (971) 4 4294 291

NEW ZEALAND

GE Lighting New Zealand
Level 1, 8 Tangihua St.
Auckland 1010
New Zealand
Tel: (64) 9 353 6706
Fax: (64) 9 353 6707

NORWAY

GE Lighting AS
Postboks 4407 Nydalen
NO-0403 Oslo
Norway
Tel: (47) 80 01 13 21
Fax: (47) 80 01 10 48

PERU

GE Lighting Peru S.A.
Avenida Paseo de la Republica y Calle
las Begonias, No. 415
Piso 14 Torre Begonias
Lima 27 – San Isidro
Peru
Tel: (51) 1 610 4347
Fax: (51) 1 610 4330

PHILIPPINES

GE Lighting Philippines, Inc.
1873 P. Domingo St.
1207 Makati City
Philippines
Tel: (63) 2 895 7051 to 53
Fax: (63) 2 325 0377

POLAND

GE Power Controls Sp. z o.o.
Ul. Leszczynska 6
43-300 Bielsko Biala
Poland
Tel: (48) 22 519 76 00
Fax: (48) 22 519 76 02

ROMANIA, MOLDOVA

VSD Merkur Lighting Group Srl
Sales Representative of
GE Hungary Kft.
Luncsoara Offices Luncsoara 14,
021232 Bucharest 2
Romania
Tel: (40) 314 378 630

RUSSIA, BELARUS, ESTONIA, LATVIA, LITHUANIA, UKRAINE, KAZAHSTAN, GEORGIA, ARMENIA

OOO "GE RUS"
Presnenskaya nab.10,
build C ,fl. 13
Moscow 123317
Russia
Tel: (7) 9169940769
Fax: (7) 4959371112

SERBIA, MONTENEGRO
VSD Merkur Group d.o.o.
Exclusive Sales Representative of
GE Hungary Kft.
Str. Mihajla Pupina 10D/105
11070 Novi Beograd
Serbia
Tel: (381) 11 311 9257

SINGAPORE
GE Pacific Pte Ltd
11 North Buona Vista Drive
Level 9, the Metropolis, Tower 2
Singapore 138589
Tel: (65) 6326 3319
Fax: (65) 6326 2090

**SLOVENIA, CROATIA,
BOSNIA AND HERZEGOVINA**
Media Light d.o.o Exclusive agent
of GE Hungary Kft.
Lighting and Power Protection
Cesta na Brdo
109 1000 Ljubljana
Slovenia
Tel: (386) 1 5304366
Fax: (386) 1 5304361

SPAIN, PORTUGAL
GE Lighting/Appliances Espana, S.A.
Rosello i Porcel, 21 - planta 10
Edificio Meridian
08016 - Barcelona
Spain
Freephone in Spain: 900 984 981
Free fax in Spain: 900 993 610

SWEDEN
GE Lighting AB
Vendevägen 89, Box 14
182 11 Danderyd
Sweden
Tel: (46) 08 51 99 22 12
Fax: (46) 08 51 99 22 14

TAIWAN
GE Lighting Taiwan
6FL, No 8, Sec 3,
Min Sheng E. Rd,
Taipei 104
Taiwan
Tel: (886) 2 2183 7000
Fax: (886) 2 2516 7356

THAILAND
GE Lighting (Thailand) Ltd.
27th floor, CRC Tower,
All Seasons Place
87/2 Wireless Road, Lumpini,
Pathumwan, Bangkok 10330
Thailand
Tel: (66) 2 250 0820-4
Fax: (66) 2 250 0825

TURKEY, ISRAEL
General Elektrik Turk Ltd.
Şti. Maslak Mah.
Eski Büyükdere Cad. No:26 K:17
34467 Istanbul
Turkey
Tel: (90) 212 214 7562
Fax: (90) 212 214 7640

**UNITED KINGDOM,
IRELAND**
GE Lighting Ltd.
Tove Valley Business Park
Old Tiffeld Road
Towcester NN12 6PF
United Kingdom
Tel: (44) 7920 711761
Fax: (44) 1543 876908

UNITED STATES OF AMERICA
GE Lighting
Nela Park, 1975 Noble Road
Cleveland, Ohio 44112
USA
Tel: (1) 216 266 2121

GE Lighting is constantly developing and improving its products. For this reason, all product descriptions in this catalogue are intended as a general guide, and we may change specifications from time to time in the interest of product development, without prior notification or public announcement. All descriptions in this publication present only general particulars of the goods to which they refer and shall not form part of any contract. Data in this guide has been obtained in controlled experimental conditions. However, GE Lighting cannot accept any liability arising from the reliance on such data to the extent permitted by law.

All lamp drawings are a guide, if further technical details are required please contact your nearest sales office.

General conditions of sale

GE Lighting products are supplied according to GE's General Conditions of Sale. If you require a copy of these conditions please contact your nearest GE Lighting sales office.

Prices

A price list is available from all GE Lighting sales offices.

www.gelighting.com/eu



and General Electric are both registered trademarks
of the General Electric Company